



# **Development of a New Brine Cavern Field for Hengelo Salt Plant:**

## **Extension of the Phase I Subsidence Prediction Model**

**for:**

**AkzoNobel Industrial Chemicals B.V.**

**Boortorenweg 27**

**P.O. Box 25**

**7550 GC, Hengelo**

**THE NETHERLANDS**

**Akzo Project: XLT Planning Hengelo**

**KBB UT Project No.: 5304-880591-D**

**Authors: 5.1.2.e**

**5.1.2.e**

**Date: 28 July 2011**

---

## Table of Contents

<b>List of Tables.....</b>	<b>2</b>
<b>1 Introduction.....</b>	<b>3</b>
<b>2 General Aspects of Surface Subsidence Modelling.....</b>	<b>5</b>
<b>3 Basic Assumptions .....</b>	<b>6</b>
3.1 Cavern Convergence .....	6
3.2 Bulking Factor and Angle of Draw .....	7
3.3 Basic Leaching Concept and Production Planning .....	8
3.4 Cavern Operation.....	8
<b>4 Results of the Surface Subsidence Modelling.....</b>	<b>10</b>
<b>5 Summary and Conclusion .....</b>	<b>13</b>
<b>List of References.....</b>	<b>16</b>
<b>List of Enclosures.....</b>	<b>17</b>
<b>Appendix A.....</b>	<b>20</b>



## List of Tables

Table 1:	Increase of subsidence with time in the centre of the subsidence bowl.....	11
Table 2:	Maximum values of subsidence with regard to assumed angle of draw 100 years after start of production .....	12

# 1 Introduction

AkzoNobel intends to create a new brine production cavern field close to the Hengelo Salt Plant in order to ensure the supply of salt for future production. The planning process is organized in three successive phases. Part I included the basic planning of the rock mechanical lay-out and leaching concept as well as the geological and technical planning for the exploration well ISH-01, while Part II comprised the drilling and evaluation of exploration well ISH-01 at Isidorushoeve, The Netherlands. DEEP. Underground Engineering (DEEP.) has been appointed by AkzoNobel for general support in the planning process with regard to site characterization and exploration as well as brine production planning. KBB Underground Technologies (KBB UT) takes part in this planning process as a subcontractor for rock mechanical and subsidence issues in cooperation with Institut für Gebirgsmechanik, Leipzig (IfG) which has also been subcontracted by DEEP.

As part of Phase I studies, a model for surface subsidence simulation was set up in order to give a first estimate on the development of the subsidence trough over time and to predict the amount of subsidence with respect to the surface area above the planned caverns. Within the scope of these investigations surface subsidence during the leaching as well as the post operation and abandonment phase of the planned caverns was taken into account.

Within Phase I predictions the focus was exclusively on subsidence, i.e. vertical displacement of the surface above the caverns. For this purpose, a KBB UT prediction model was applied and the results of this initial subsidence study were summarized and presented in a report [1].

The KBB UT model, however, currently produces no additional information on subsidence related values such as tilt and strains which are required e.g. for the environmental impact study (MER) of the new brine production cavern field for the Hengelo salt plant and which have to be provided in due time according to the time schedule of the project.

Therefore, it was decided by AkzoNobel and KBB UT to build-up a comparable subsidence model based on the generally accepted software SaltSubsid as the required additional data can be generated with this code. This software is distributed by the Solution Mining Research Institute (SMRI) and publicly available for MS Windows based computers. Further, this code has already been used by AkzoNobel.

However, there are differences in the modelling procedure if either SaltSubsid or the KBB UT procedure is applied. Thus, it cannot be expected that identical results will be generated in terms of predicted surface subsidence values. Further, each code/procedure has its advantages or disadvantages with regard to the consideration of specific aspects of modelling, e.g. consideration of the field development, time dependency of angle of draw or general availability of the software. Therefore, a more detailed comparison of both codes/procedures can be carried out in an extra study within the scope of Phase III planning when required from a permit track perspective.

Predictions of surface subsidence due to brine production have to consider the field development plan of the caverns and how their volume convergence develops over time. Both aspects are taken into account by making use of the results of studies that have been performed within the scope of Phase I of the current project [2], [3].

In the present report, a general overview on the process of subsidence modelling is given in Chapter 2. The basic assumptions for the set-up of the subsidence model are described in Chapter 3. The results of the calculations are discussed in Chapter 4 and shown by contour line maps related to the surface area at Isidorushoeve in terms of vertical displacements (maps of isocatabases) as well as tilts and strains at selected points in time. The report ends up with an overall summary given in Chapter 5.

## 2 General Aspects of Surface Subsidence Modeling

The general idea behind surface subsidence modelling is that volume losses caused by mining activities at subsurface lead to surface subsidence.

As part of surface subsidence predictions an assumption has to be made on the mechanism how the volume losses at subsurface are transferred to surface. This means that it has to be described in which shape the subsidence bowl will generally develop, how far it will laterally extend and how it grows with volume losses at subsurface. With respect to salt caverns this means that the development of the subsidence bowl over time has to be considered as a consequence of salt creep behaviour.

A generally accepted model for subsidence caused by caverns in rock salt was developed by SROKA and SCHOBBER (1982) [4] and generalized by EICKEMEIER (2005) [5]. This subsidence model is implemented in the SaltSubsid software that is used for predictions within the scope of this study. More detailed information about the theoretical background of implemented models and their necessary input parameters is given in the SaltSubsid user's manual [6]. However, the general ideas of the applied model and the therein assumed values are briefly presented in the following while the governing formulae describing the SROKA/SCHOBBER model are provided in Appendix A.

General ideas of the SROKA/SCHOBBER subsidence model can be summarized as follows:

- a normalized Gaussian type is used as shape function of the subsidence bowl (or trough) which is influenced by some specific parameters. Of major importance are the angle of draw  $\beta$ , the bulking factor  $a$  of the overlying rocks due to subsidence movements and the cavern convergence rate  $V_C(t)/dt$ .
- the angle of draw  $\beta$  identifies the area at surface that is influenced by volume losses  $V_C(t)$  at the subsurface. It is measured against the horizontal and referenced to a representative cavern depth.
- the bulking factor  $a$  describes the ratio of convergence volume produced at the subsurface compared to the subsidence volume revealing at the surface.
- the convergence rate  $V_C(t)/dt$  describes the loss of cavern cavity volume over time.

## 3 Basic Assumptions

### 3.1 Cavern Convergence

With respect to brine production caverns, the ability of the surrounding rock salt mass to creep continuously leads to volume losses of the caverns (convergence) and therefore subsidence at surface. As creep processes continue, subsidence increases over time. However, the rate of volume convergence can be limited to small values, when the pressure in the caverns is maintained at relatively high levels. This is especially relevant in the post leaching phase after brine production. Finally, when caverns have been sealed, the convergence rate will continuously decrease to very small values as during the abandonment phase, the driving force for creep diminishes due to an increasing internal cavern pressure. In the applied SaltSubsid model this is considered by assuming different creep rates with respect to the different operation modes (brine production / post production / abandonment).

Estimates on volume convergence of these caverns that are required as input for the subsidence prediction model have been assumed on the basis of the rock mechanical study of IfG Leipzig (2010) [3] performed during Phase I, in which the convergence rate of a generic type of brine production cavern at Isidorushoeve was calculated using a numerical simulation model. It must be noted that the exact final volumes of the caverns as well as their development over time cannot be determined in advance. Therefore, a generic type of cavern was used for the rock mechanical modelling which is considered to be representative with regard to the design (e.g. shape, diameter and depth location, geological environment) as well as layout (operation pressures) of all planned caverns. In respect to the location in the field this generic type cavern represents a cavern in the centre of the planned cavern field, i.e. a cavern with neighbours to all sides in a hexagonal grid. This approach led to a cavern predesign with a maximum diameter of the rock mechanical envelope of 135 m and a spacing of 300 m between cavern axes.

The key results of the rock mechanical study of IfG (2010) [3] are that

- the stability of the rock salt surrounding the caverns can be demonstrated according to the assumptions made and

- the calculated steady state values for cavern convergence rate are 0.2 %/year during cavern operation at 0 bar wellhead pressure, and 0.04 %/year at wellhead pressures of 50 bar.

In the subsidence model a cavern convergence rate of 0.2 %/year is adopted for the leaching and subsequent post leaching while the cavern convergence rate during abandonment is represented by a value of 0.04 %/year.

Since the local creep behaviour of the rock salt mass at Isidorushoeve – an essential parameter influencing the calculation of cavern volume convergence – is unknown, yet, creep parameters of Isidorushoeve salt were estimated by IfG on the basis of their experience in testing of rock salts from various locations. Specific data for strength and creep of salt from Isidorushoeve will be generated in the course of Phase III, i.e. the subsidence prognosis may have to be updated if creep response of the Isidorushoeve salt appears to be substantially different from the characteristic values adopted from experience by IfG.

### 3.2 Bulking Factor and Angle of Draw

While the cavern convergence has to be calculated based on the selected cavern design and location as well as site specific material behaviour, parameters like the bulking factor  $a$  and the angle of draw  $\beta$  are estimated based on experience. Within the scope of this study the bulking factor  $a$  is assumed to be 1. This way it is conservatively presumed that convergence volume and produced surface subsidence volume are of the same value. The angle of draw differs from location to location and can change over time of operation due to the long-term creep of the salt. However, in SaltSubsid only fixed values for the angle of draw can be taken into account. With regard to long-term subsidence observations above salt caverns, this value can be assumed to range between 35° and 45°. Over long periods it is likely that the angle of draw will become smaller due to the overall creep behavior of the salt deposit (see [7] and [8]). Therefore, within the scope of the present study, an angle of draw of 40° was selected which can be considered as a reliable value with regard to subsidence predictions above the planned caverns at Isidorushoeve. Again it must be noted that subsidence predictions never produce exact values compared to what will be observed over time in reality. However, the expected range of subsidence values can be shown by varying the value for the angle of draw.



Therefore, the effect of using an angle of draw of 35° and 45° were additionally studied for year 100 after start of production. Principally, it can be noticed that an assumed lower value of the angle of draw leads to the prediction of smaller subsidence values while the area of the subsidence bowl is larger.

### **3.3 Basic Leaching Concept and Production Planning**

The applied prediction model is based on the basic leaching concept for the new brine production field [2]. According to this concept, 70 caverns will be leached at the new location until they reach a maximum diameter of 112 m, corresponding to a diameter of the rock mechanical envelope of 125 m. This cavern design differs to the one set up by IfG (see Chapter 3.1). In the leaching concept it was assumed that a maximum cavern diameter of 112 m, corresponding to a maximum diameter of 125 m when applying an utilization factor (leached volume compared to rock mechanical volume) of 80 %, is sufficient for the required salt production and beneficial in respect to the minimization of subsidence effects.

Four cavern types were differentiated by height (ranging between 120 m and 245 m) according to the assumed individual thickness of the salt layer. Their distribution throughout the cavern field is shown in Enclosure 1.

The development of the cavern field over time is taken into account as described in the DEEP. concept. Operations are assumed to start at the beginning of 2015, whereas the last cavern will be finalized in the second half of 2067. Field development will be from east to west. The progress of cavern volume over time is individually considered for each cavern.

### **3.4 Cavern Operation**

It is assumed that the wellhead will be at atmospheric pressure during the leaching progress. The same conservative assumption is supposed to be valid within the time span of one year that precedes the abandonment phase of the cavern. The time span needed for preparing the caverns for sealing may be longer for the first caverns because of a principle testing phase. However, one year seems to be a reasonable value with regard to the total number of 70 caverns.



At the beginning of the abandonment phase the caverns will have been ultimately sealed. As a consequence, the pressure in the cavern will build up and the rate of volume convergence will decrease continuously. As a conservative approach, the wellhead pressure during cavern abandonment is assumed to be 50 bars.

## 4 Results of the Surface Subsidence Modeling

Selected results of subsidence prediction are presented in terms of characteristic parameters referenced to a topographic map of the project area. They are shown for selected points in time, i.e. 10, 25, 50, 75 and 100 years after start of leaching of the first cavern to demonstrate the development of the subsidence bowl over time. The data selected from the output of the SaltSubsid software are as follows:

- vertical displacements,
- rates of vertical displacements,
- resulting tilts,
- compressive strains,
- tensile strains,
- curvatures with reference to Easting,
- curvatures with reference to Northing.

Due to the fact that the proposed leaching sequence starts in the eastern part of the cavern field, the subsidence bowl develops from east to west (compare Enclosures 2 to 6). For the same reasons the predicted maximum value of surface subsidence appears in the eastern centre above the cavern field and stays there over the whole time span modelled. A secondary bowl is not created. Relative maximum values of subsidence can always be identified along a virtual central line through the surface projection of the cavern field.

From the succession of maps representing the vertical displacement (isocatabases) the predicted progress of surface subsidence trough can be anticipated (Enclosures 2 to 6). It can be clearly identified that the area affected by the subsidence trough extends while maximum subsidence values increase. The increase of the maximum value of subsidence in the individual centre of the bowl is shown in Table 1.

**Table 1:** Increase of subsidence with time in the centre of the subsidence bowl

Time after Start of Production [Years]	Maximum value of subsidence in the centre of the bowl after 100 a [m]
10	0.06
25	0.21
50	0.38
75	0.55
100	0.72

The subsidence rate (vertical displacement rate) increases during the first production period and slows down to values of about 6 mm/year while the area affected by a displacement rate of 6 mm/year extends (see Enclosures 9 to 13). After 100 years two areas of relative maxima for the subsidence rate can be identified.

Resulting tilts show maximum values of 1 mm/m at 100 years after start of production (see Enclosures 14 to 18). Two areas where maximum tilts have developed can be identified in the eastern part above the cavern field in a kind of symmetry with regard to a virtual central line through the cavern field.

Compressive strains are at maximum above the centre of the eastern part of the cavern field where maximum vertical displacements concentrate, too (see Enclosures 19 to 23). Tensile strains (see Enclosures 24 to 28) are predicted to appear preferably at the flanks of subsidence bowl. 100 years after start of production, both strain maps show a kind of symmetry with regard to a virtual central line through the cavern field. Maximum values are about -900 mm/km (-0.9 ‰) for compressive and about 400 mm/km (0.4 ‰) for tensile strains.

The curvature map with regard to Easting (see Enclosure 33) shows a maximum value of about 0.001 /km after 100 years above the centre in the eastern part of the cavern field in concave mode. Two additional areas with concave curvature follow in western direction.

A kind of symmetry can be identified in the map representing curvature with regard to Northing at 100 years after start of operations (see Enclosures 38). Above the virtual central line of the cavern field concave curvatures are predicted to be at maximum values (slightly above 0.0025 /km). At the lateral flanks above the cavern field convex Northing curvatures are predicted (about 1.5 /km in maximum).

In order to evaluate the influence of the angle of draw on the modelling results, Enclosures 7 and 8 show the subsidence bowls (vertical displacements) 100 years after

start of production as modelled by assuming an angle of draw of 35° and 45, respectively. Comparing the individual subsidence bowls it can be seen how the area affected by subsidence extends with decreasing angle of draw while the maximum value in the centre of the bowl decreases (compare Enclosures 6 to 8). The predicted individual maximum values of subsidence in the centre of the bowl are also given in Table 2 with regard to assumed angle of draw.

**Table 2:** Maximum values of subsidence with regard to assumed angle of draw 100 years after start of production

Assumed angle of draw [ ° ]	Maximum value of subsidence in the centre of the bowl after 100 a [m]
35	0.62
40	0.72
45	0.81

## 5 Summary and Conclusion

Surface subsidence will be generated above the future brine field as a consequence of the intended brine production around Isidorushoeve.

Surface subsidence in terms of vertical displacements and related characteristic values such as subsidence rates, resulting tilts, compressive and tensile strains as well as Easting and Northing related curvatures are presented in maps superimposed to the geographical map of the Isidorushoeve area. Different points in time representing 10, 25, 50, 75 and 100 years after start of leaching were selected in order to show the development of the subsidence bowl and its characteristics with time.

With respect to Phase I subsidence predictions, the new model currently leads to larger subsidence values due to the fact, that e.g. the change of the angle of draw over time cannot be modeled with SaltSubsid.

The basis for assuming reduced convergence rates during the production and abandonment phase due to the number of adjacent caverns, which would also have a diminishing effect on the subsidence rates, has not been investigated to a sufficient extent, yet. This would be necessary in order to state an adequate degree of conservatism which is required for the on-going planning process. Nevertheless, Phase I predictions indicate, that subsidence may turn out to be smaller than resulting from the current model.

The subsidence bowl generally follows the progress of the production process. As brine production starts in the eastern part of the cavern field, subsidence starts here to reveal at surface and progresses into western direction, while the maximum value of subsidence stays in the eastern part of the field. Due to the fact that surface subsidence directly depends on cavern convergence as well as on existing or created cavern volume, the rate of subsidence slows down towards the end of the production phase, because additional cavern volume is not created at the same rate as before. Furthermore, the number of abandoned caverns increases. The abandonment period is considered in the prediction model by assuming a smaller convergence rate. Thus, the global rate of volume convergence is reduced and the long-term rate of subsidence is predicted to be about 7 mm/year.

For year 100 after the start of brine production, the subsidence bowl can be characterised by the following:

- maximum vertical displacements are predicted to 0.72 m,
- resulting tilts add up to 1 mm/m,
- maximum strains are about 0.9 ‰ in compression and about 0.4 ‰ in tension,
- curvatures with regard to Easting or Northing remain in the range between 3.5 /km (concave mode) and -1.5 /km (convex mode),
- an additional prediction assuming an angle of draw of 45° results in a smaller extent of the subsidence bowl and a greater maximum value of the vertical displacement (0.81 m) if compared to the prediction assuming an angle of draw of 40°. The opposite is true if a smaller value of 35° is assumed (predicted maximum vertical displacement of 0.62 m).

Apart from the concept for the timely development (number of caverns and created volume at subsurface) conservative assumptions have been made for several important factors that influence the calculation of surface subsidence, as site-specific values are not yet available. These assumptions can be described and summarized as following:

- The specific material behaviour of the salt at Isidorushoeve is not known, yet. This is essential, because the creep ability directly influences the convergence behaviour of the caverns and therefore the subsidence at surface. However, laboratory tests with site specific core material will be carried out within Phase III of the project.
- Cavern convergence depends on individual leached cavern shapes and operation pressures. Realized cavern shapes may substantially deviate from the applied generic cavern model. However, applied cavern design parameters can be regarded as a maximum enveloping outline for the planned caverns.
- Pressure conditions of the caverns during the post operation phase are not identified very clearly. The duration of the intermediate phase between brine production and abandonment has to be defined as well as the pressure level during this period. Therefore a conservative approach has been made by assuming atmospheric wellhead pressure during the post leaching phase.

- The pressure build-up after cavern sealing is unknown. This will be mitigated by performing a rock mechanical study about cavern abandonment within Phase III. The study cannot be started before the site specific material testing in the laboratory has been finished.

With regard to Phase I subsidence modelling it can be stated that the subsidence model now applied in Phase III is a bit more conservative. While comparing the two models, first of all the individually adopted cavern convergence rates have to be considered. IfG calculated convergence rates for a generic cavern type in the middle of the field with a fixed ratio of cavern diameter to salt pillar extent. However, during field development the number of adjacent caverns varies over time. Furthermore, there will be caverns that even in the final state after production will have a reduced number of neighbouring caverns. Eventually, cavern convergence will slightly decrease if the ratio of the pillar width to cavern diameter increases, e.g. if the cavern maximum diameter is assumed to 112 m while cavern spacing is still set to 300 m.

It can be concluded that within Phase I of the project a subsidence model was created that took into account the main factors influencing subsidence in more detail than is possible with the software used for the current model. As a result, smaller subsidence values were calculated. However, with a growing knowledge on site specific, e.g. creep characteristics and convergence with respect to cavern and pillar dimensions it will also be possible to refine the actual SaltSubsid model. With regard to future investigations, e.g. the environmental impact study, the currently applied subsidence prediction model does also offer an adequate robustness. Moreover it also provides additional data on important parameters as e.g. strain, curvature and tilt.



## List of References

- [1] KBB Underground Technologies GmbH (2010): Development of a New Brine Cavern Field for Hengelo Salt Plant: Basic Subsidence Predictions, Hannover.
- [2] DEEP. Underground Engineering (2010): Development of a New Brine Cavern Field for Hengelo Salt Plant: Basic Leaching Concepts and Development of the Haaksbergen Site, Bad Zwischenahn.
- [3] Institut für Gebirgsmechanik, Leipzig (2010): Rock Mechanical Investigations and Dimensioning for the new AkzoNobel NaCl-Brine Production Field, Haaksbergen.
- [4] Sroka, A., Schober, F. (August 1982): Die Berechnung der maximalen Bodenbewegung über kavernenartigen Hohlräumen unter Berücksichtigung der Hohlraumgeometrie, Kali und Steinsalz.
- [5] Eickemeier, R. (2005): Senkungsprognosen über Kavernenfeldern - Ein neues Modell, Tagungsbeitrag zum 34. Geomechanik-Kolloquium, Leipzig.
- [6] Respec and POD Associates, Inc. (April 2009): SALT\_SUBSID User's Manual, Version 2.
- [7] Gaulke, K., Rokahr, R., Staudtmeister, K., Zander-Schiebenhöfer, D. 2007: Re-assessment of the Creep Behaviour of the Rüstringen Salt Dome for Optimization and Future Development of the Crude Oil Cavern Storage Facility, SMRI Technical Paper, Fall Conference.
- [8] Zander-Schiebenhöfer, D. 2007: Kriechverhalten von Salzgestein in der Umgebung von Kavernenfeldern, Forschungsergebnisse aus dem Tunnel- und Kavernenbau Gottfried Wilhelm Leibniz Universität Hannover, Heft 23, Hannover.
- [9] MWH B.V. (2008): Study of the Salt Mining Possibilities in the Haaksbergen Area, the Netherlands, report, 82 pp + appendices/enclosures.
- [10] Neuhaus, W.(1976): Die Berechnungsgrundlagen der bergschadenkundlichen Einwirkungsnetze und ihre Möglichkeiten und Grenzen, Mitteilungen aus dem Markscheidewesen, 83, Heft 2, Deutscher Markscheider-Verein e.V., Essen.

## List of Enclosures

- Enclosure 1: Cavern Field Layout based on the basic leaching concept of DEEP. 2010
- Enclosure 2: Isidorushoeve – Vertical displacements –  $\beta=40^\circ$  – 10 years after start of production
- Enclosure 3: Isidorushoeve – Vertical displacements –  $\beta=40^\circ$  – 25 years after start of production
- Enclosure 4: Isidorushoeve – Vertical displacements –  $\beta=40^\circ$  – 50 years after start of production
- Enclosure 5: Isidorushoeve – Vertical displacements –  $\beta=40^\circ$  – 75 years after start of production
- Enclosure 6: Isidorushoeve – Vertical displacements –  $\beta=40^\circ$  – 100 years after start of production
- Enclosure 7: Isidorushoeve – Vertical displacements –  $\beta=35^\circ$  – 100 years after start of production
- Enclosure 8: Isidorushoeve – Vertical displacements –  $\beta=45^\circ$  – 100 years after start of production
- Enclosure 9: Isidorushoeve – Vertical displacement rates –  $\beta=40^\circ$  – 10 years after start of production
- Enclosure 10: Isidorushoeve – Vertical displacement rates –  $\beta=40^\circ$  – 25 years after start of production
- Enclosure 11: Isidorushoeve – Vertical displacement rates –  $\beta=40^\circ$  – 50 years after start of production
- Enclosure 12: Isidorushoeve – Vertical displacement rates –  $\beta=40^\circ$  – 75 years after start of production
- Enclosure 13: Isidorushoeve – Vertical displacement rates –  $\beta=40^\circ$  – 100 years after start of production
- Enclosure 14: Isidorushoeve – Resulting tilts –  $\beta=40^\circ$  – 10 years after start of production

- Enclosure 15: Isidorushoeve – Resulting tilts –  $\beta=40^\circ$  – 25 years after start of production
- Enclosure 16: Isidorushoeve – Resulting tilts –  $\beta=40^\circ$  – 50 years after start of production
- Enclosure 17: Isidorushoeve – Resulting tilts –  $\beta=40^\circ$  – 75 years after start of production
- Enclosure 18: Isidorushoeve – Resulting tilts –  $\beta=40^\circ$  – 100 years after start of production
- Enclosure 19: Isidorushoeve – Compressive strains –  $\beta=40^\circ$  – 10 years after start of production
- Enclosure 20: Isidorushoeve – Compressive strains –  $\beta=40^\circ$  – 25 years after start of production
- Enclosure 21: Isidorushoeve – Compressive strains –  $\beta=40^\circ$  – 50 years after start of production
- Enclosure 22: Isidorushoeve – Compressive strains –  $\beta=40^\circ$  – 75 years after start of production
- Enclosure 23: Isidorushoeve – Compressive strains –  $\beta=40^\circ$  – 100 years after start of production
- Enclosure 24: Isidorushoeve – Tensile strains –  $\beta=40^\circ$  – 10 years after start of production
- Enclosure 25: Isidorushoeve – Tensile strains –  $\beta=40^\circ$  – 25 years after start of production
- Enclosure 26: Isidorushoeve – Tensile strains –  $\beta=40^\circ$  – 50 years after start of production
- Enclosure 27: Isidorushoeve – Tensile strains –  $\beta=40^\circ$  – 75 years after start of production
- Enclosure 28: Isidorushoeve – Tensile strains –  $\beta=40^\circ$  – 100 years after start of production

Enclosure 29: Isidorushoeve – Curvature with reference to Easting –  $\beta=40^\circ$  – 10 years after start of production

Enclosure 30: Isidorushoeve – Curvature with reference to Easting –  $\beta=40^\circ$  – 25 years after start of production

Enclosure 31: Isidorushoeve – Curvature with reference to Easting –  $\beta=40^\circ$  – 50 years after start of production

Enclosure 32: Isidorushoeve – Curvature with reference to Easting –  $\beta=40^\circ$  – 75 years after start of production

Enclosure 33: Isidorushoeve – Curvature with reference to Easting –  $\beta=40^\circ$  – 100 years after start of production

Enclosure 34: Isidorushoeve – Curvature with reference to Northing –  $\beta=40^\circ$  – 10 years after start of production

Enclosure 35: Isidorushoeve – Curvature with reference to Northing –  $\beta=40^\circ$  – 25 years after start of production

Enclosure 36: Isidorushoeve – Curvature with reference to Northing –  $\beta=40^\circ$  – 50 years after start of production

Enclosure 37: Isidorushoeve – Curvature with reference to Northing –  $\beta=40^\circ$  – 75 years after start of production

Enclosure 38: Isidorushoeve – Curvature with reference to Northing –  $\beta=40^\circ$  – 100 years after start of production

Enclosure A.1 Subsidence trough at surface due to volume losses at subsurface according to Neuhaus (1976) [10].

## Appendix A

### Basic description of the Applied Sroka/Schober Model

Formulae used by the applied Sroka/Schober subsidence prediction model which has been selected in the SaltSubsid code are presented in the following. A general visualization of the subsidence trough is given in Enclosure A.1.

#### Applied formulas for subsidence prediction according to SROKA und SCHOBER (1982)

$$s(r,t) = a \cdot f(r,t) \cdot V_C(t) \quad \text{equation A.1}$$

with

- $s(r,t)$  value of surface subsidence with regard to location  $r$  and time  $t$
- $a$  bulking factor
- $f(r,t)$  shape function of the subsidence bowl on surface
- $V_C(t)$  convergence volume (volume losses) with regard to time
- $r$  radius from cavern axis according to equation A.3
- $t$  time

#### Simplified shape function of subsidence bowl

$$f(r) = \frac{1}{R^2} \cdot e^{\left(-\pi \left(\frac{r}{R}\right)^2\right)} \quad \text{equation A.2}$$

with

- $R$  representative maximum radius of the subsidence bowl (see equation A3.4)
- $r$  radius from cavern axis according to equation A.3

#### Identification of surface point with regard to cavern axis

$$r = \sqrt{(x - x_K)^2 + (y - y_K)^2} \quad \text{equation A.3}$$

with

- $x_K, y_K$  coordinates of cavern axis in ground map view

Definition of representative maximum radius of volume convergence

$$R = \frac{\sqrt{z_u \cdot z_o}}{\tan \beta}$$

equation A.4

with



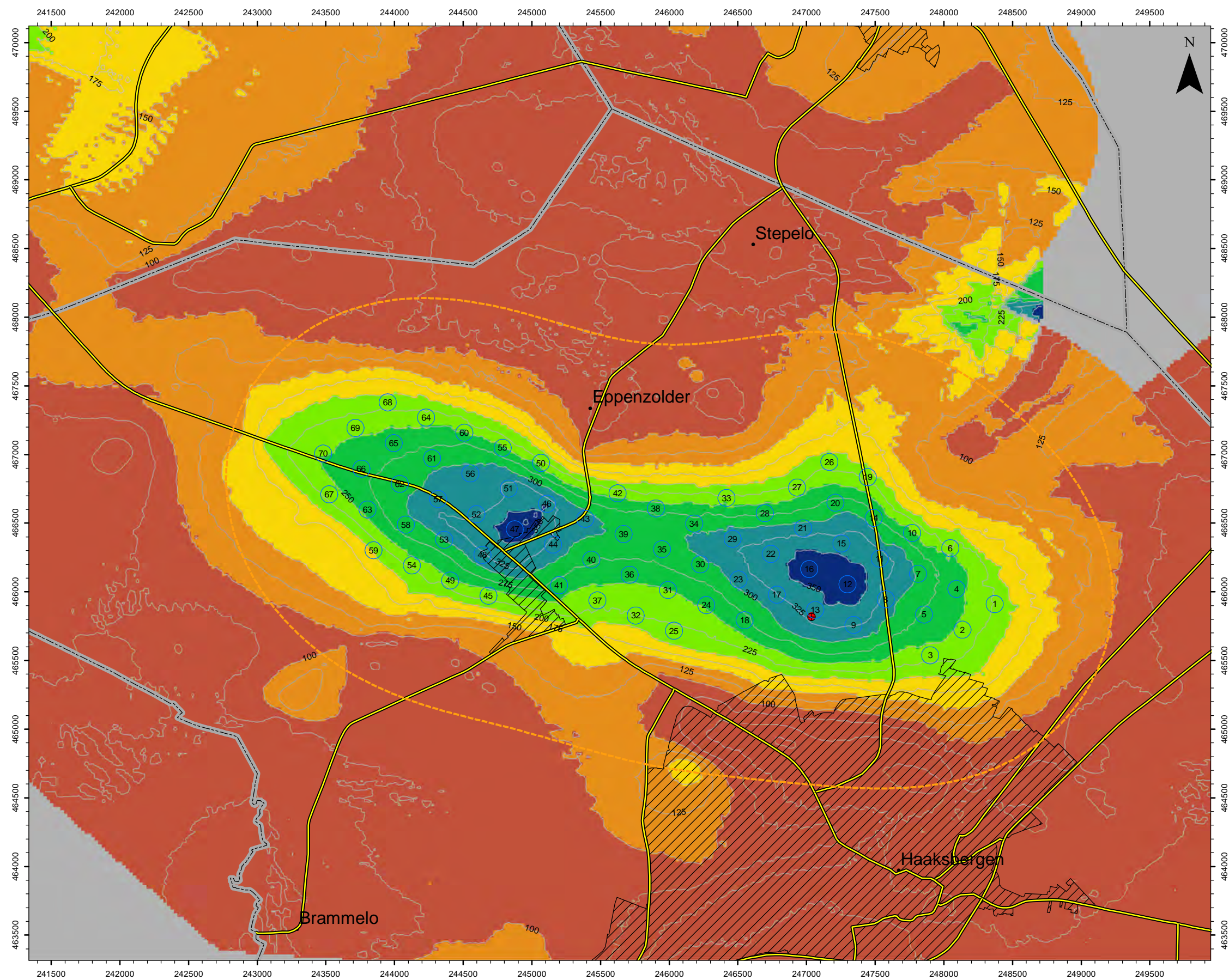

$R$	representative maximum radius of the subsidence bowl
$z_u$	depth of deepest point of the cavern
$z_o$	depth of cavern roof
$\beta$	angle of draw

The above given formulae cover the calculation of subsidence generated by a single cavern, whereas in reality several caverns will be leached. Thus, the subsidence troughs of all caverns have to be superimposed.













**Legend**

-  Rock mechanical envelope: 125 m
-  ISH-01
-  Municipal boundary
-  Residential area
-  Roads

**Thickness of Z1 (Werra) Halite (m)**

-  < 100
-  100 - 150
-  150 - 200
-  200 - 250
-  250 - 300
-  300 - 350
-  > 350

-  Cavern No. - Cavern Type

**Reference**

MWH B.V. (12/2008):  
Study of the Salt Mining  
Possibilities in the Haaksbergen  
Area, the Netherlands, report,  
82 pp + appendices/enclosures.

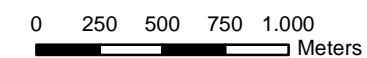





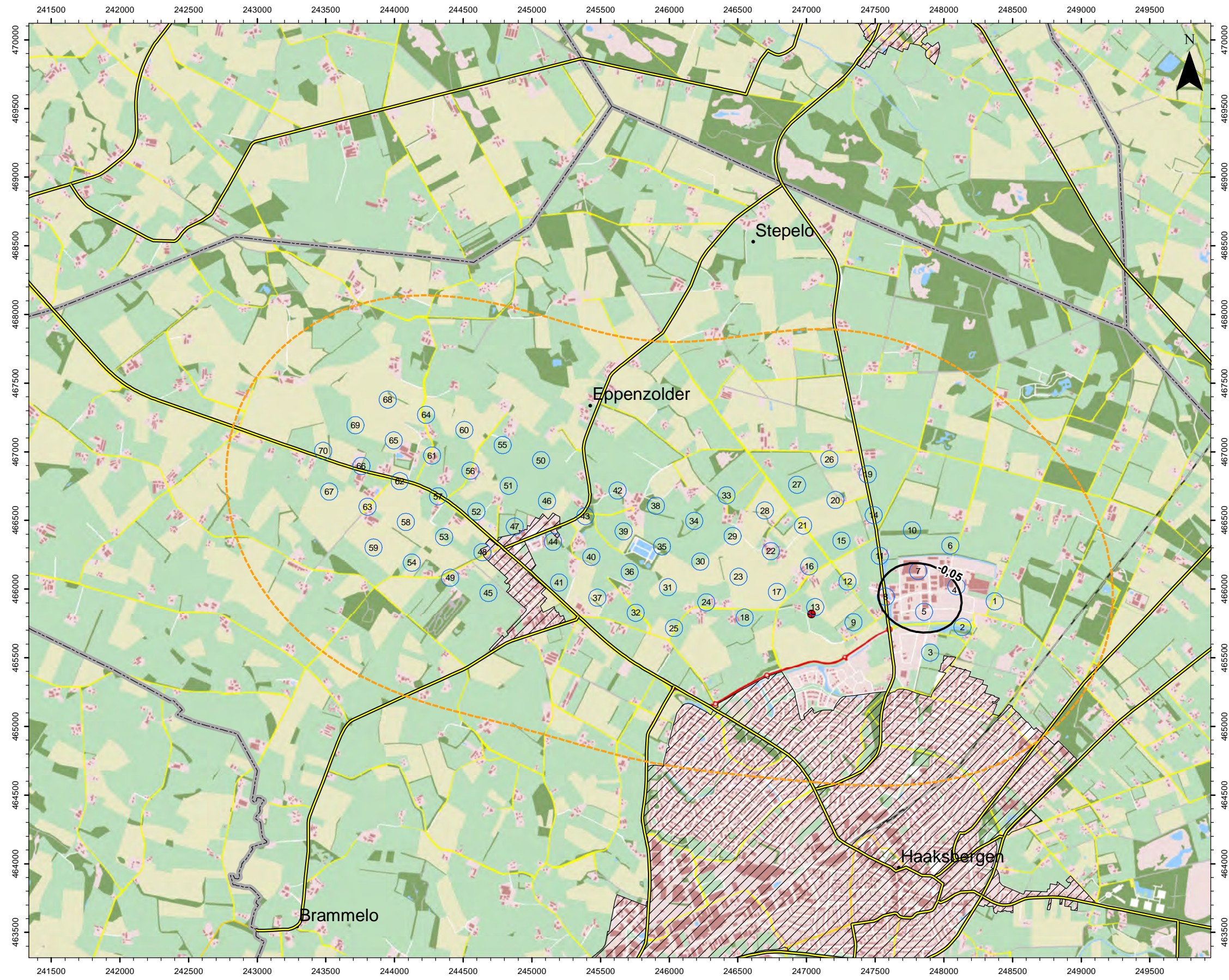

**Enclosure 1: Cavern Field Layout based on the basic leaching concept of DEEP. (2010)**





**Legend**

-  Rock mechanical envelope: 125 m
-  Estimated boundary of subsidence trough (2 cm isocatabase, angle of draw 30°, 100 a after start of production)
-  ISH-01
-  Municipal boundary
-  Residential area
-  Roads
-  Isoline [m]

**Reference**

MWH B.V. (12/2008):  
 Study of the Salt Mining  
 Possibilities in the Haaksbergen  
 Area, the Netherlands, report,  
 82 pp + appendices/enclosures.







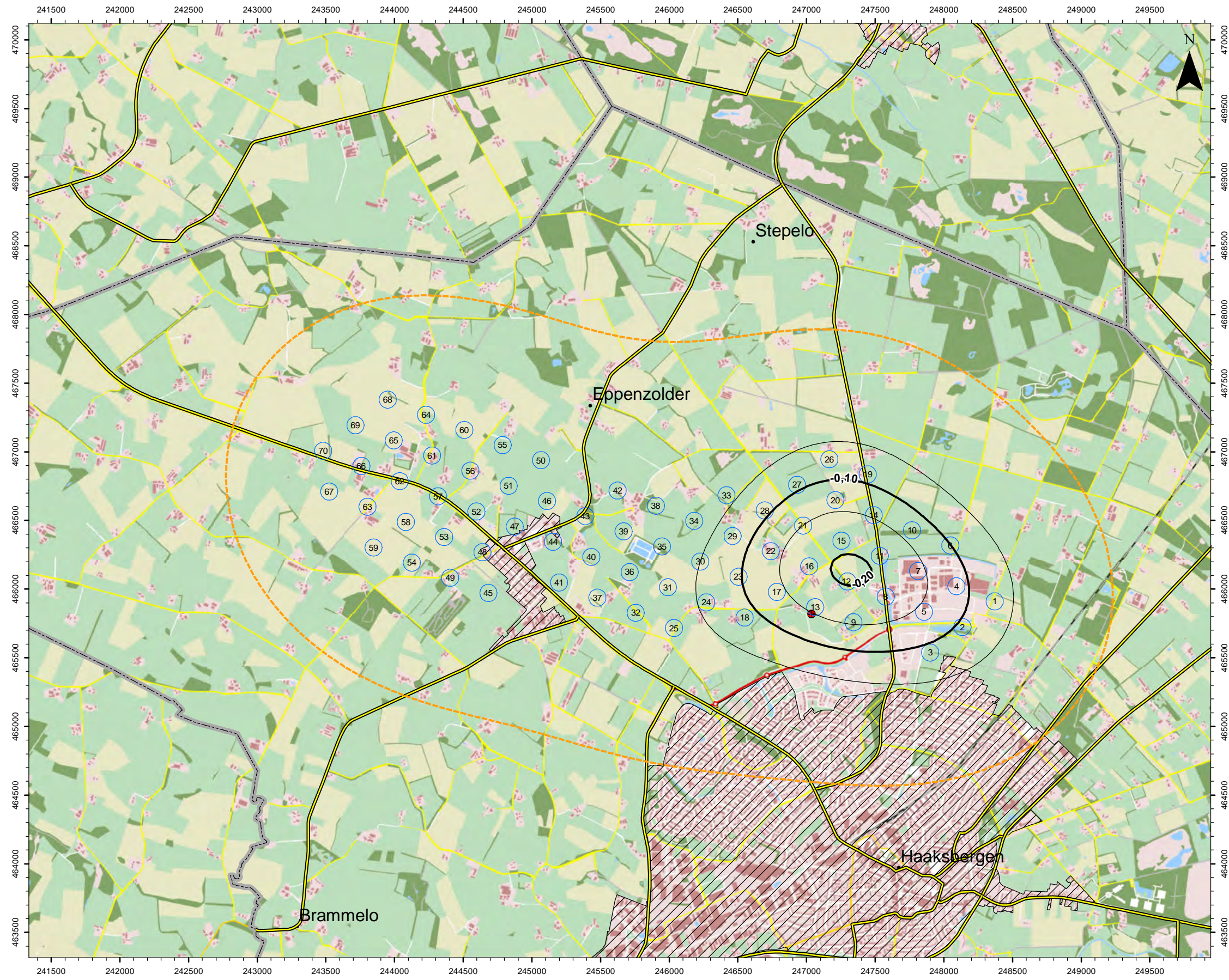

**Enclosure 2: Isidorushoeve – Vertical displacement [m] –  $\beta=40^\circ$  – 10 years after start of production**





**Legend**

-  Rock mechanical envelope: 125 m
-  Estimated boundary of subsidence trough (2 cm isocatabase, angle of draw 30°, 100 a after start of production)
-  ISH-01
-  Municipal boundary
-  Residential area
-  Roads
-  Isoline [m]

**Reference**

MWH B.V. (12/2008):  
 Study of the Salt Mining  
 Possibilities in the Haaksbergen  
 Area, the Netherlands, report,  
 82 pp + appendices/enclosures.







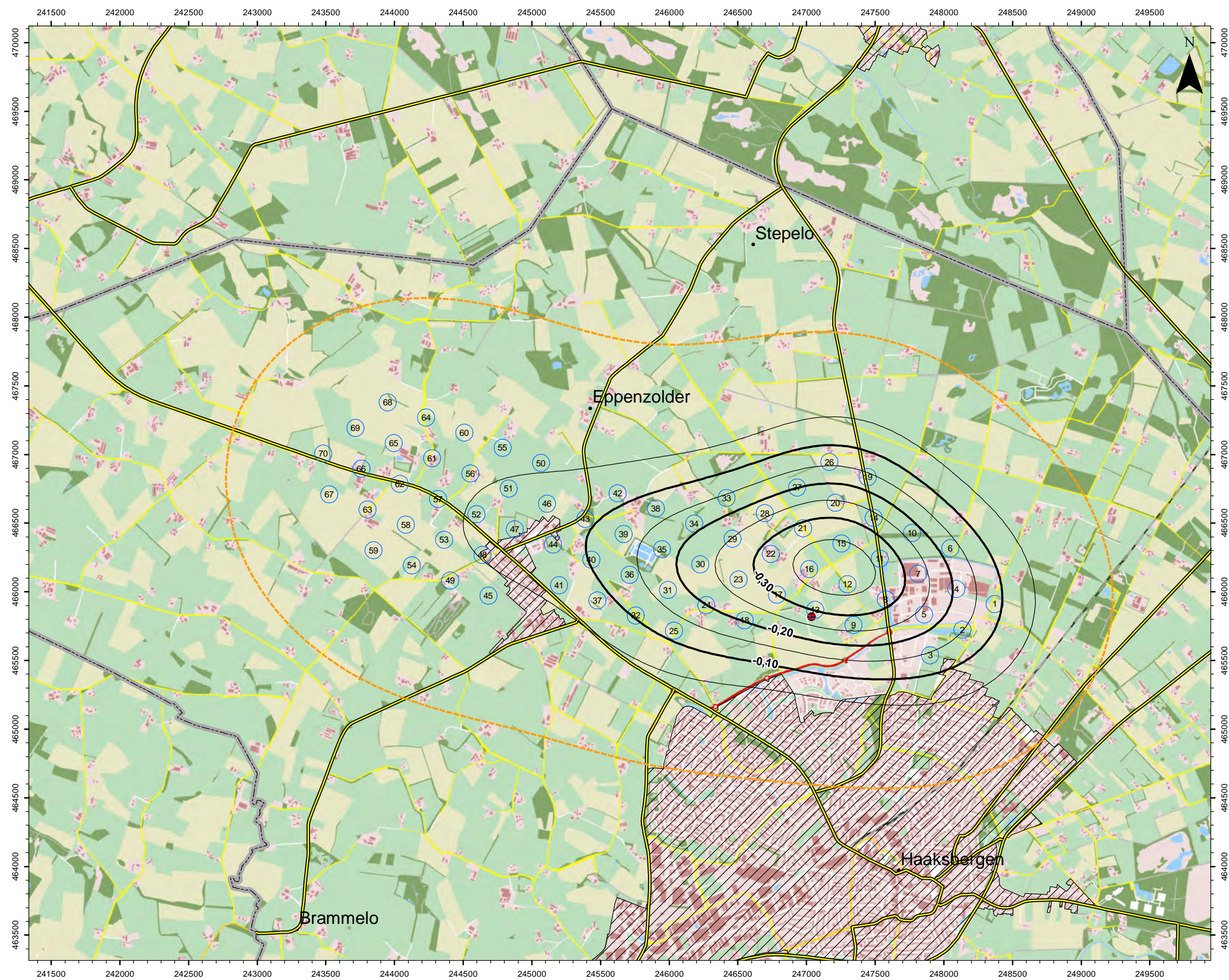

**Enclosure 3: Isidorushoeve – Vertical displacement [m] –  $\beta=40^\circ$  – 25 years after start of production**





**Legend**

-  Rock mechanical envelope: 125 m
-  Estimated boundary of subsidence trough (2 cm isocatabase, angle of draw 30°, 100 a after start of production)
-  ISH-01
-  Municipal boundary
-  Residential area
-  Roads
-  Isoline [m]

**Reference**

MWH B.V. (12/2008):  
Study of the Salt Mining  
Possibilities in the Haaksbergen  
Area, the Netherlands, report,  
82 pp + appendices/enclosures.

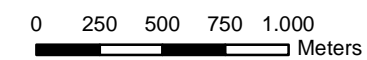





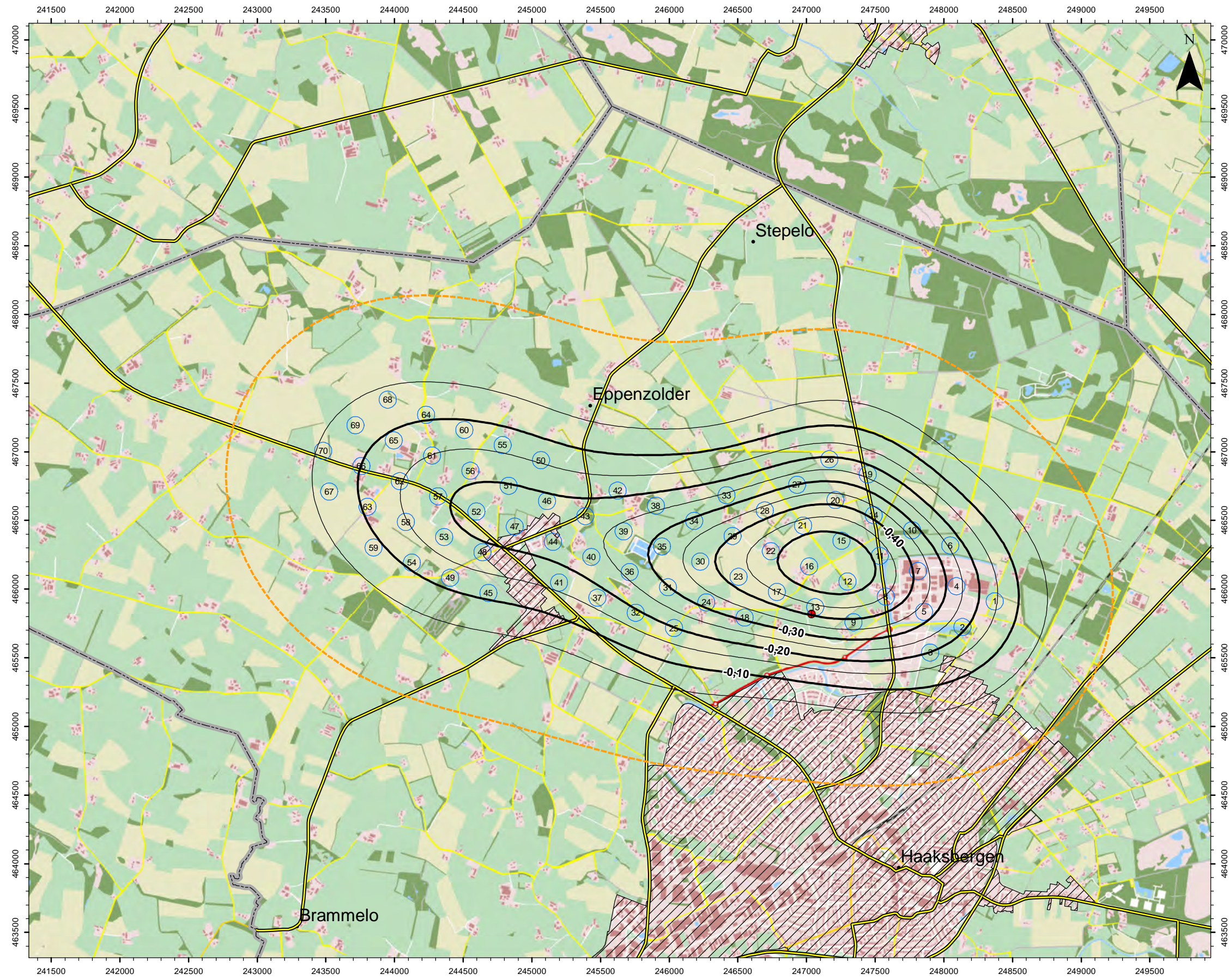

**Enclosure 4: Isidorushoeve – Vertical displacement [m] –  $\beta=40^\circ$  – 50 years after start of production**





**Legend**

-  Rock mechanical envelope: 125 m
-  Estimated boundary of subsidence trough (2 cm isocatabase, angle of draw 30°, 100 a after start of production)
-  ISH-01
-  Municipal boundary
-  Residential area
-  Roads
-  Isoline [m]

**Reference**

MWH B.V. (12/2008):  
 Study of the Salt Mining  
 Possibilities in the Haaksbergen  
 Area, the Netherlands, report,  
 82 pp + appendices/enclosures.







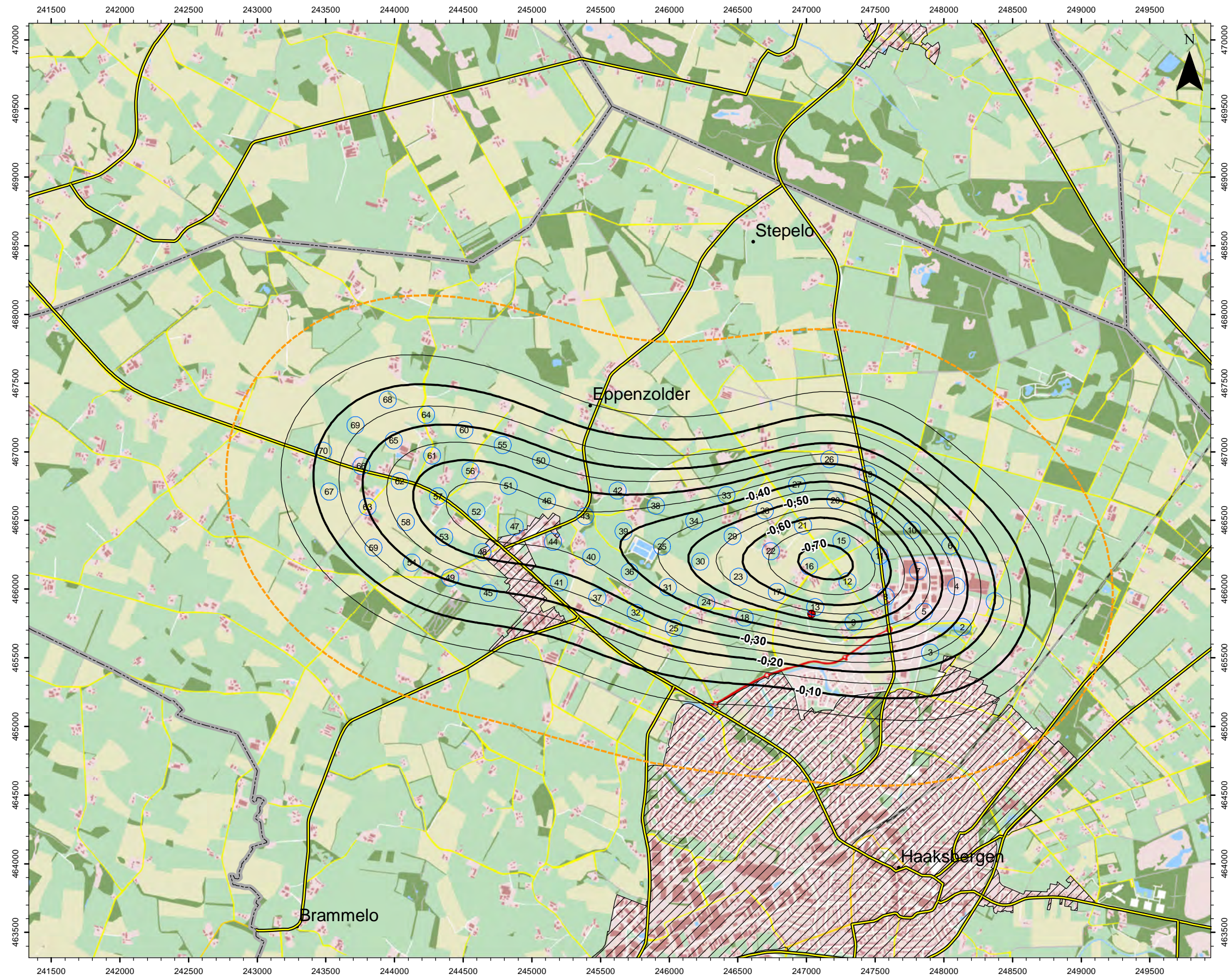

**Enclosure 5: Isidorushoeve – Vertical displacement [m] –  $\beta=40^\circ$  – 75 years after start of production**





**Legend**

-  Rock mechanical envelope: 125 m
-  Estimated boundary of subsidence trough (2 cm isocatabase, angle of draw 30°, 100 a after start of production)
-  ISH-01
-  Municipal boundary
-  Residential area
-  Roads
-  Isoline [m]

**Reference**

MWH B.V. (12/2008):  
Study of the Salt Mining  
Possibilities in the Haaksbergen  
Area, the Netherlands, report,  
82 pp + appendices/enclosures.







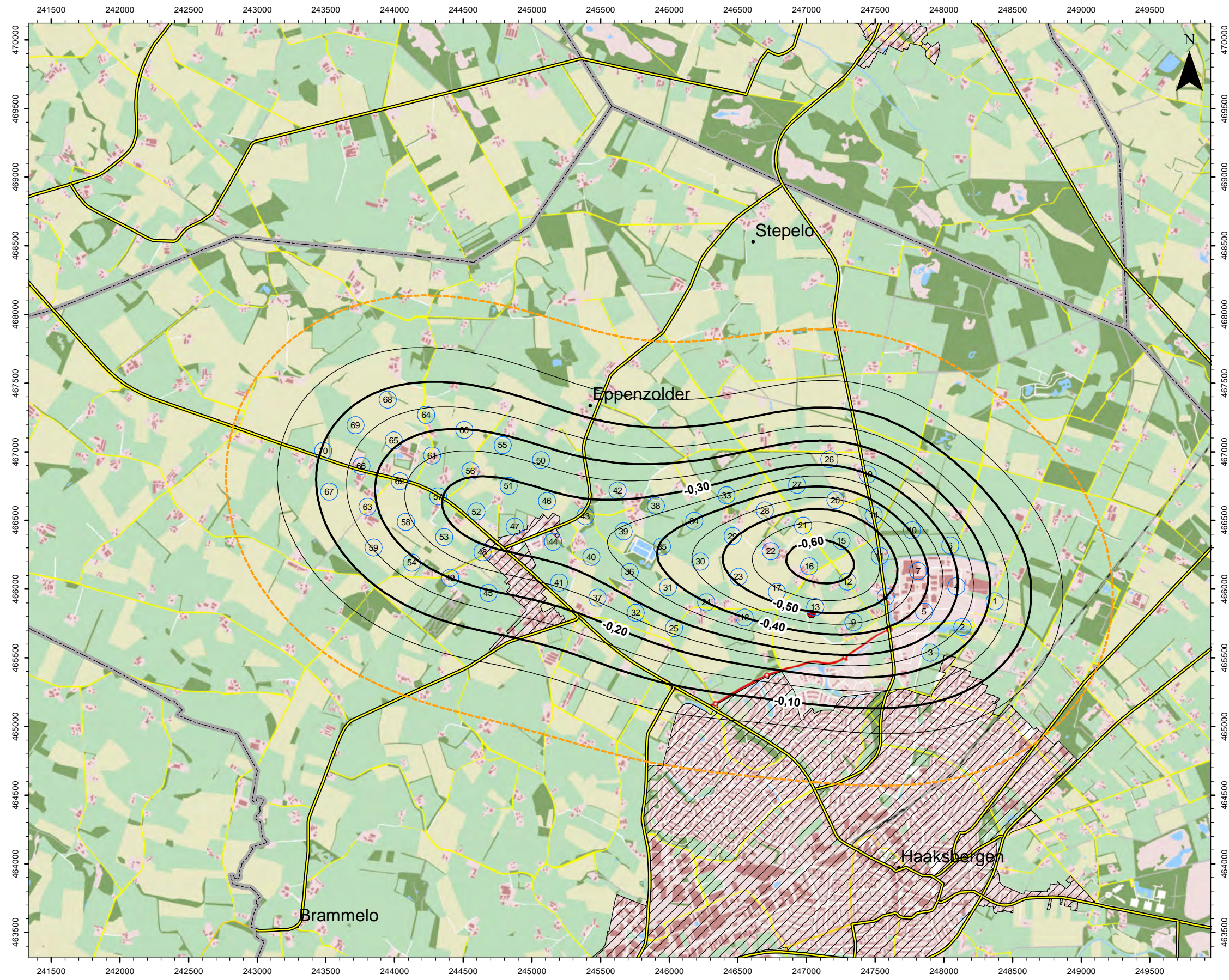

**Enclosure 6: Isidorushoeve – Vertical displacement [m] –  $\beta=40^\circ$  – 100 years after start of production**





**Legend**

-  Rock mechanical envelope: 125 m
-  Estimated boundary of subsidence trough (2 cm isocatabase, angle of draw 30°, 100 a after start of production)
-  ISH-01
-  Municipal boundary
-  Residential area
-  Roads
-  Isoline [m]

**Reference**

MWH B.V. (12/2008):  
 Study of the Salt Mining  
 Possibilities in the Haaksbergen  
 Area, the Netherlands, report,  
 82 pp + appendices/enclosures.







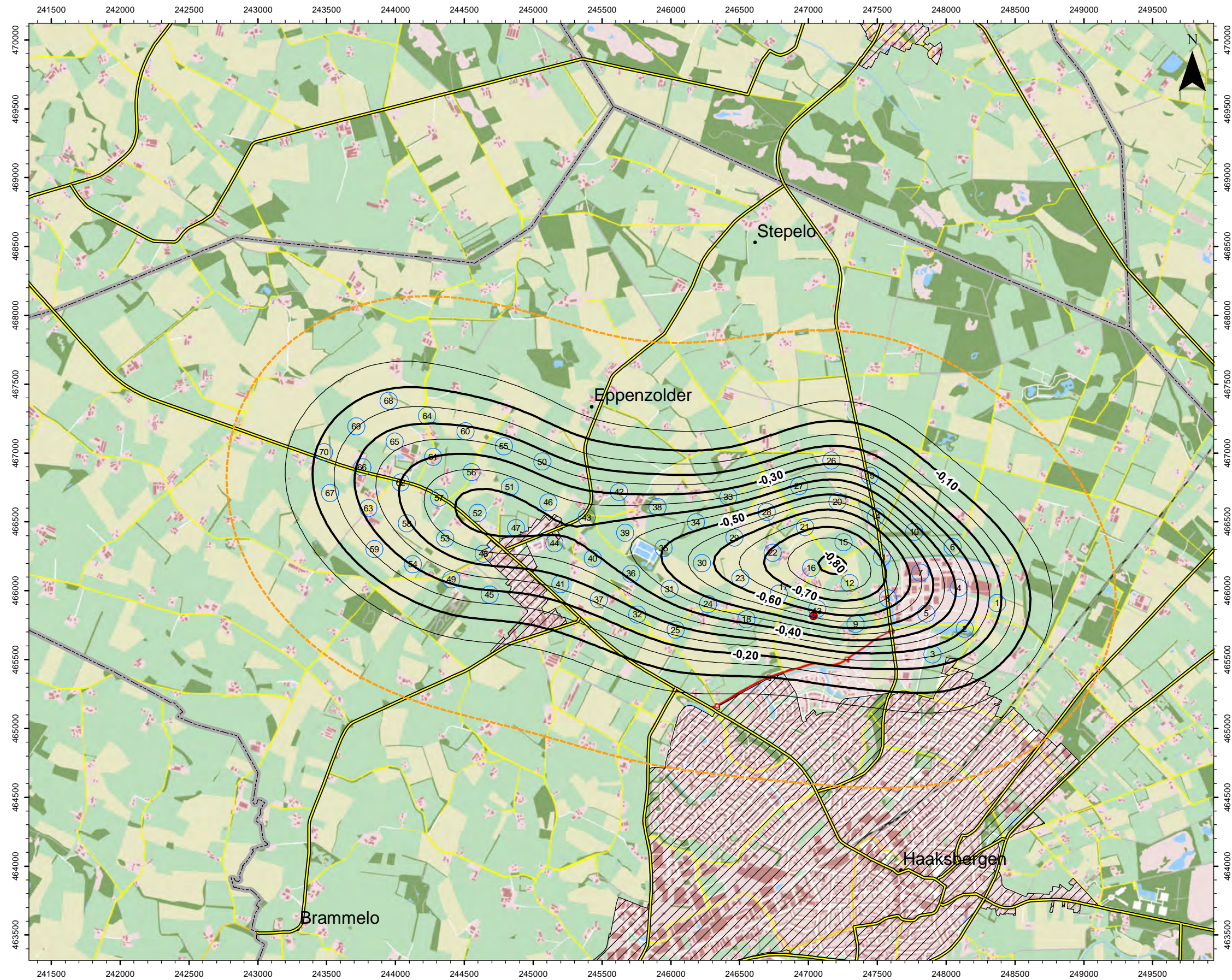

**Enclosure 7: Isidorushoeve – Vertical displacement [m] –  $\beta=35^\circ$  – 100 years after start of production**





**Legend**

-  Rock mechanical envelope: 125 m
-  Estimated boundary of subsidence trough (2 cm isocatabase, angle of draw 30°, 100 a after start of production)
-  ISH-01
-  Municipal boundary
-  Residential area
-  Roads
-  Isoline [m]

**Reference**

MWH B.V. (12/2008):  
 Study of the Salt Mining  
 Possibilities in the Haaksbergen  
 Area, the Netherlands, report,  
 82 pp + appendices/enclosures.

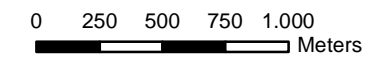





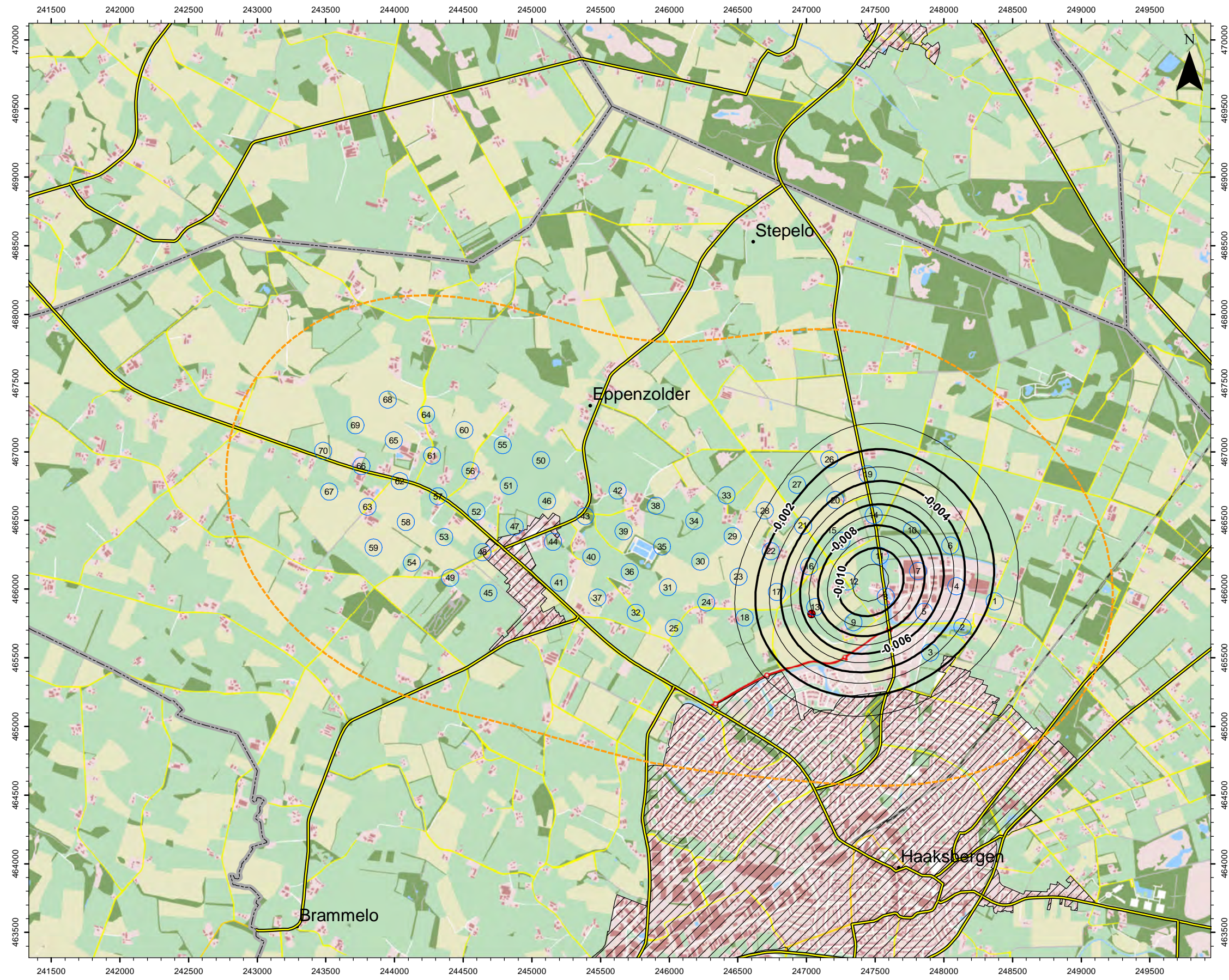

**Enclosure 8: Isidorushoeve – Vertical displacement [m] –  $\beta=45^\circ$  – 100 years after start of production**





**Legend**

-  Rock mechanical envelope: 125 m
-  Estimated boundary of subsidence trough (2 cm isocatabase, angle of draw 30°, 100 a after start of production)
-  ISH-01
-  Municipal boundary
-  Residential area
-  Roads
-  Isoline [m/a]

**Reference**

MWH B.V. (12/2008):  
 Study of the Salt Mining  
 Possibilities in the Haaksbergen  
 Area, the Netherlands, report,  
 82 pp + appendices/enclosures.

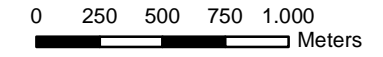





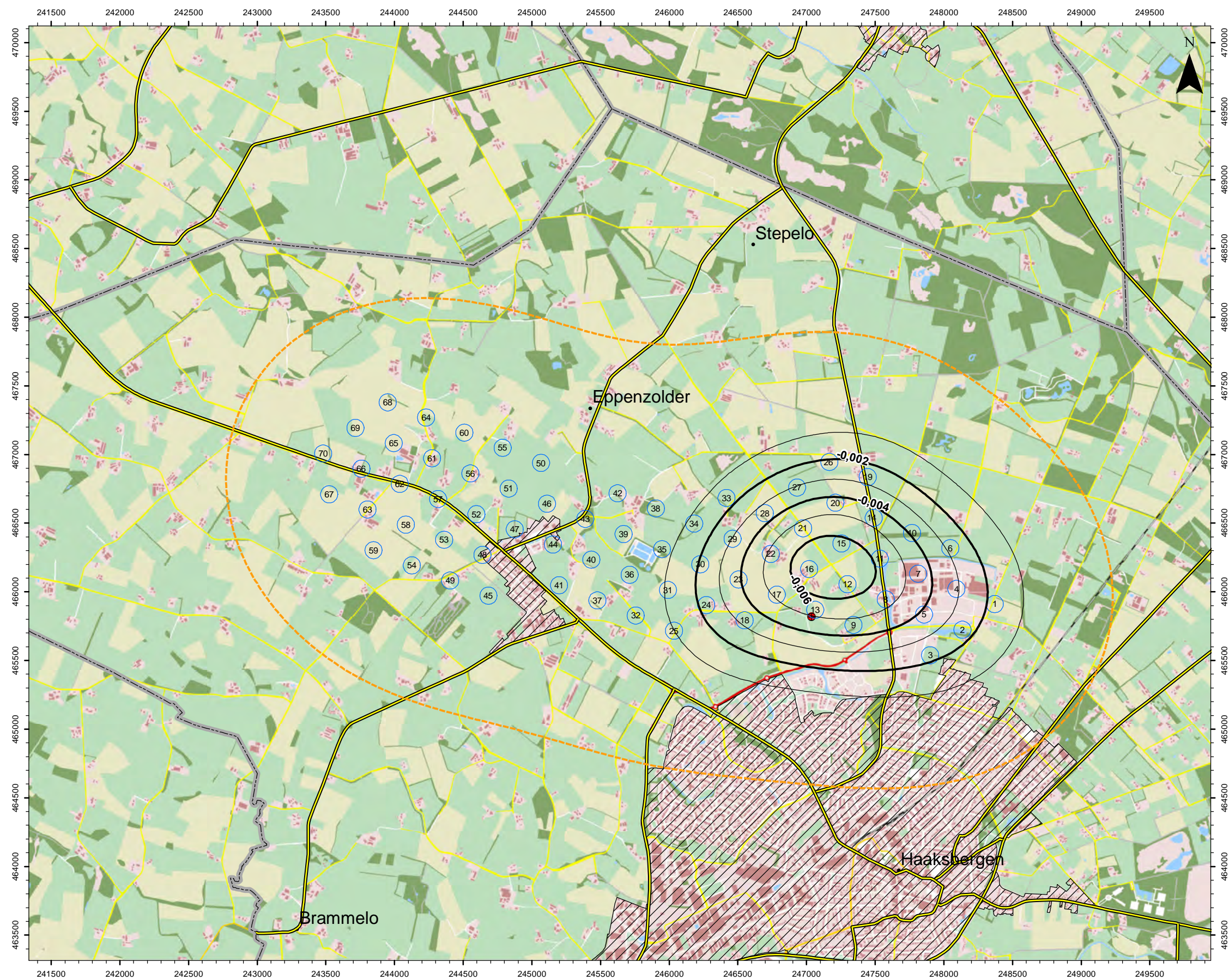

**Enclosure 9: Isidorushoeve – Vertical displacement rates [m/a] –  $\beta=40^\circ$  – 10 years after start of production**





**Legend**

-  Rock mechanical envelope: 125 m
-  Estimated boundary of subsidence trough (2 cm isocatabase, angle of draw 30°, 100 a after start of production)
-  ISH-01
-  Municipal boundary
-  Residential area
-  Roads
-  Isoline [m/a]

**Reference**

MWH B.V. (12/2008):  
Study of the Salt Mining  
Possibilities in the Haaksbergen  
Area, the Netherlands, report,  
82 pp + appendices/enclosures.

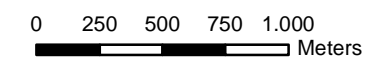





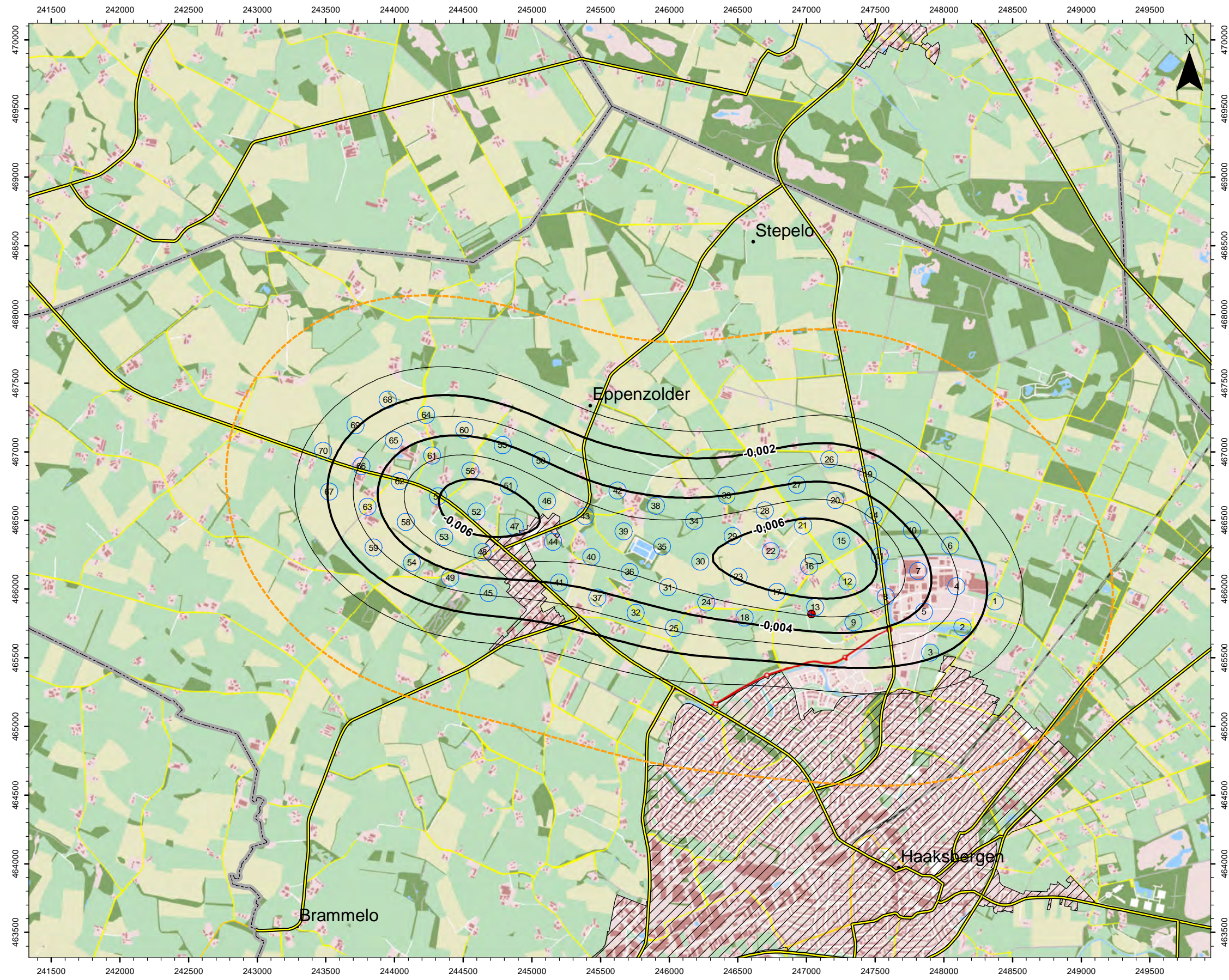

**Enclosure 10: Isidorushoeve – Vertical displacement rates [m/a] –  $\beta=40^\circ$  – 25 years after start of production**





**Legend**

-  Rock mechanical envelope: 125 m
-  Estimated boundary of subsidence trough (2 cm isocatabase, angle of draw 30°, 100 a after start of production)
-  ISH-01
-  Municipal boundary
-  Residential area
-  Roads
-  Isoline [m/a]

**Reference**

MWH B.V. (12/2008):  
 Study of the Salt Mining  
 Possibilities in the Haaksbergen  
 Area, the Netherlands, report,  
 82 pp + appendices/enclosures.







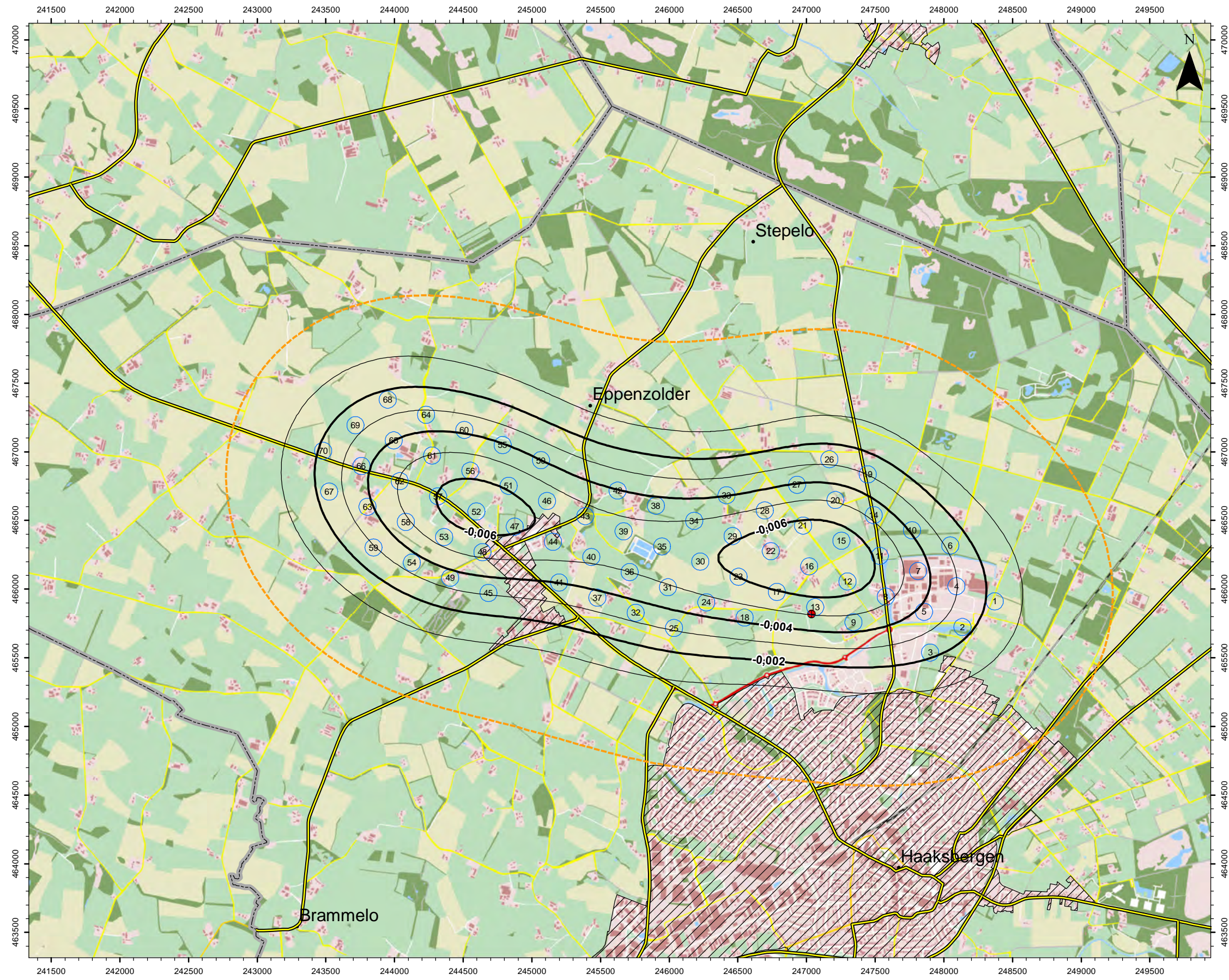

**Enclosure 11: Isidorushoeve – Vertical displacement rates [m/a] –  $\beta=40^\circ$  – 50 years after start of production**





**Legend**

-  Rock mechanical envelope: 125 m
-  Estimated boundary of subsidence trough (2 cm isocatabase, angle of draw 30°, 100 a after start of production)
-  ISH-01
-  Municipal boundary
-  Residential area
-  Roads
-  Isoline [m/a]

**Reference**

MWH B.V. (12/2008):  
Study of the Salt Mining  
Possibilities in the Haaksbergen  
Area, the Netherlands, report,  
82 pp + appendices/enclosures.







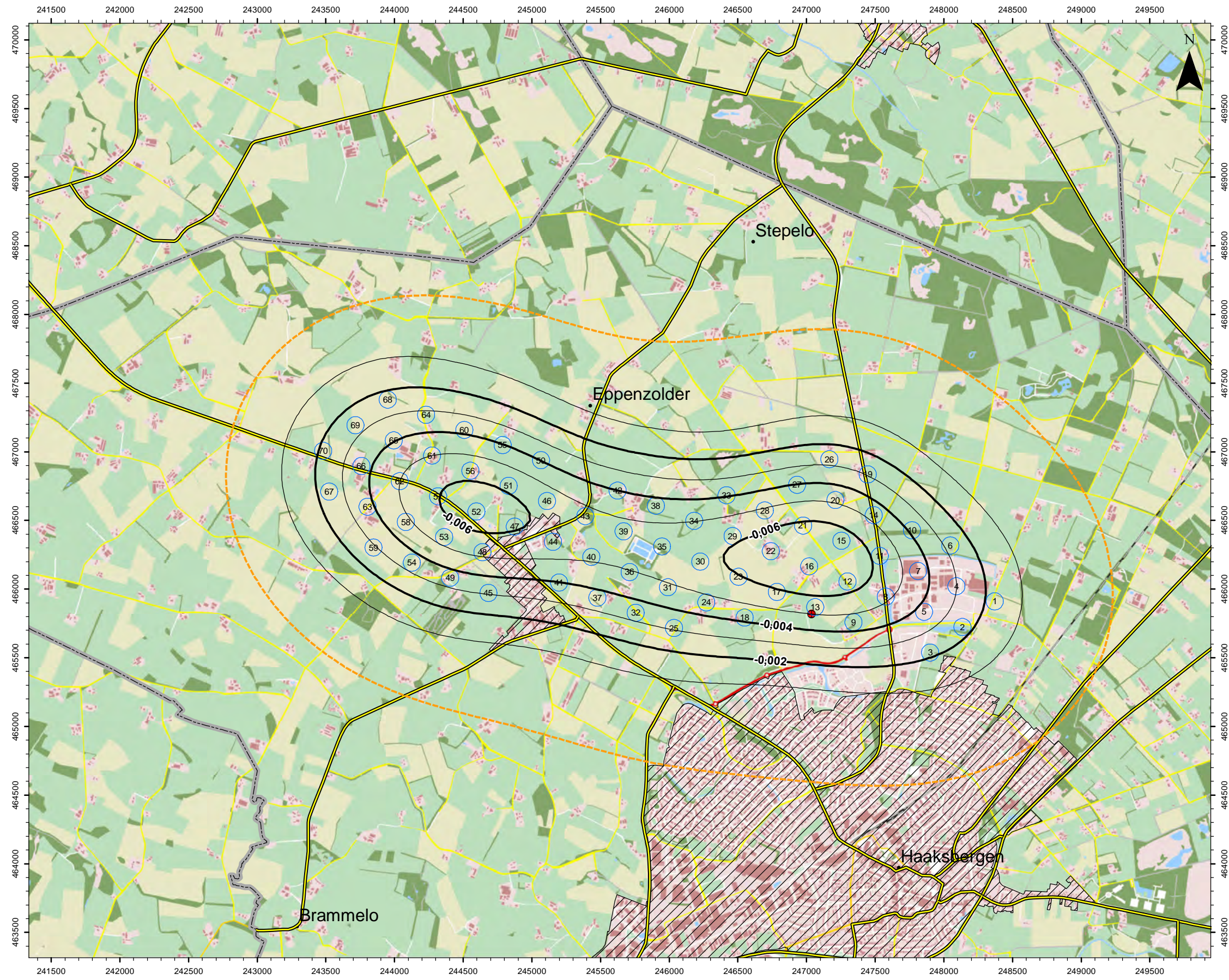

**Enclosure 12: Isidorushoeve – Vertical displacement rates [m/a] –  $\beta=40^\circ$  – 75 years after start of production**





**Legend**

-  Rock mechanical envelope: 125 m
-  Estimated boundary of subsidence trough (2 cm isocatabase, angle of draw 30°, 100 a after start of production)
-  ISH-01
-  Municipal boundary
-  Residential area
-  Roads
-  Isoline [m/a]

**Reference**

MWH B.V. (12/2008):  
 Study of the Salt Mining  
 Possibilities in the Haaksbergen  
 Area, the Netherlands, report,  
 82 pp + appendices/enclosures.







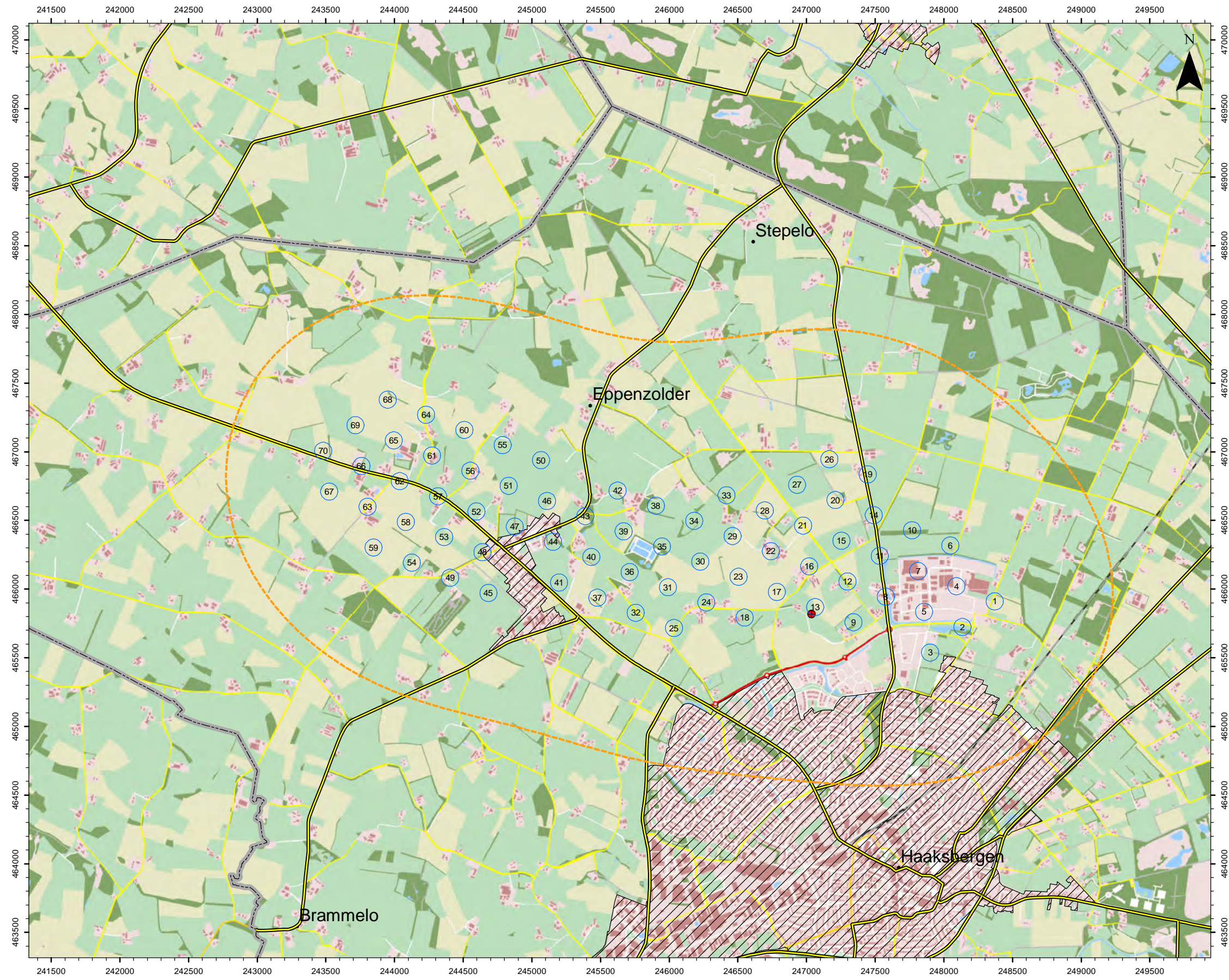

**Enclosure 13: Isidorushoeve – Vertical displacement rates [m/a] –  $\beta=40^\circ$  – 100 years after start of production**





**Legend**

-  Rock mechanical envelope: 125 m
-  Estimated boundary of subsidence trough (2 cm isocatabase, angle of draw 30°, 100 a after start of production)
-  ISH-01
-  Municipal boundary
-  Residential area
-  Roads
-  Isoline [m/m]

**Reference**

MWH B.V. (12/2008):  
Study of the Salt Mining  
Possibilities in the Haaksbergen  
Area, the Netherlands, report,  
82 pp + appendices/enclosures.







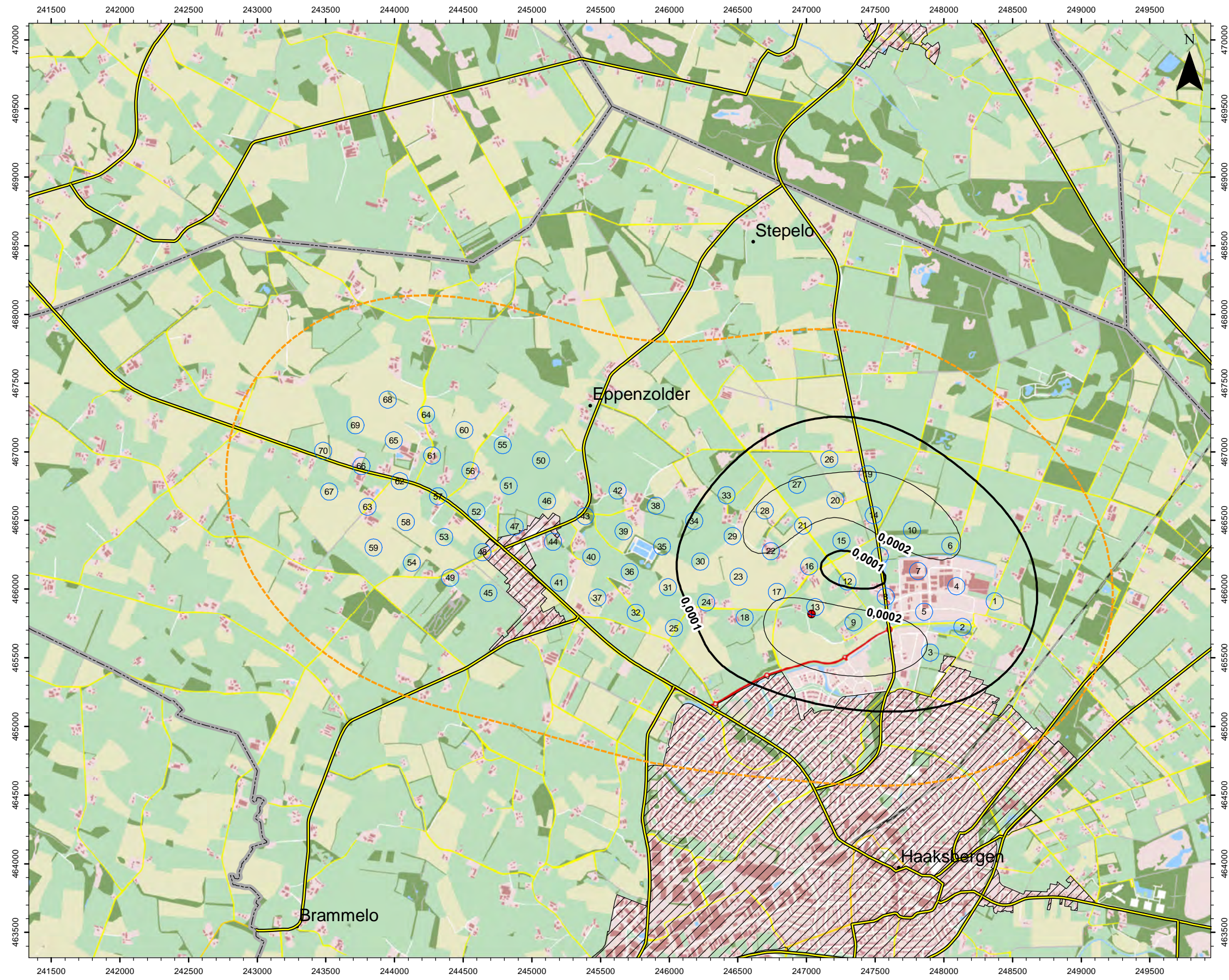

**Enclosure 14: Isidorushoeve – Resulting tilts [m/m] –  $\beta=40^\circ$  – 10 years after start of production**





**Legend**

-  Rock mechanical envelope: 125 m
-  Estimated boundary of subsidence trough (2 cm isocatabase, angle of draw 30°, 100 a after start of production)
-  ISH-01
-  Municipal boundary
-  Residential area
-  Roads
-  Isoline [m/m]

**Reference**

MWH B.V. (12/2008):  
 Study of the Salt Mining  
 Possibilities in the Haaksbergen  
 Area, the Netherlands, report,  
 82 pp + appendices/enclosures.







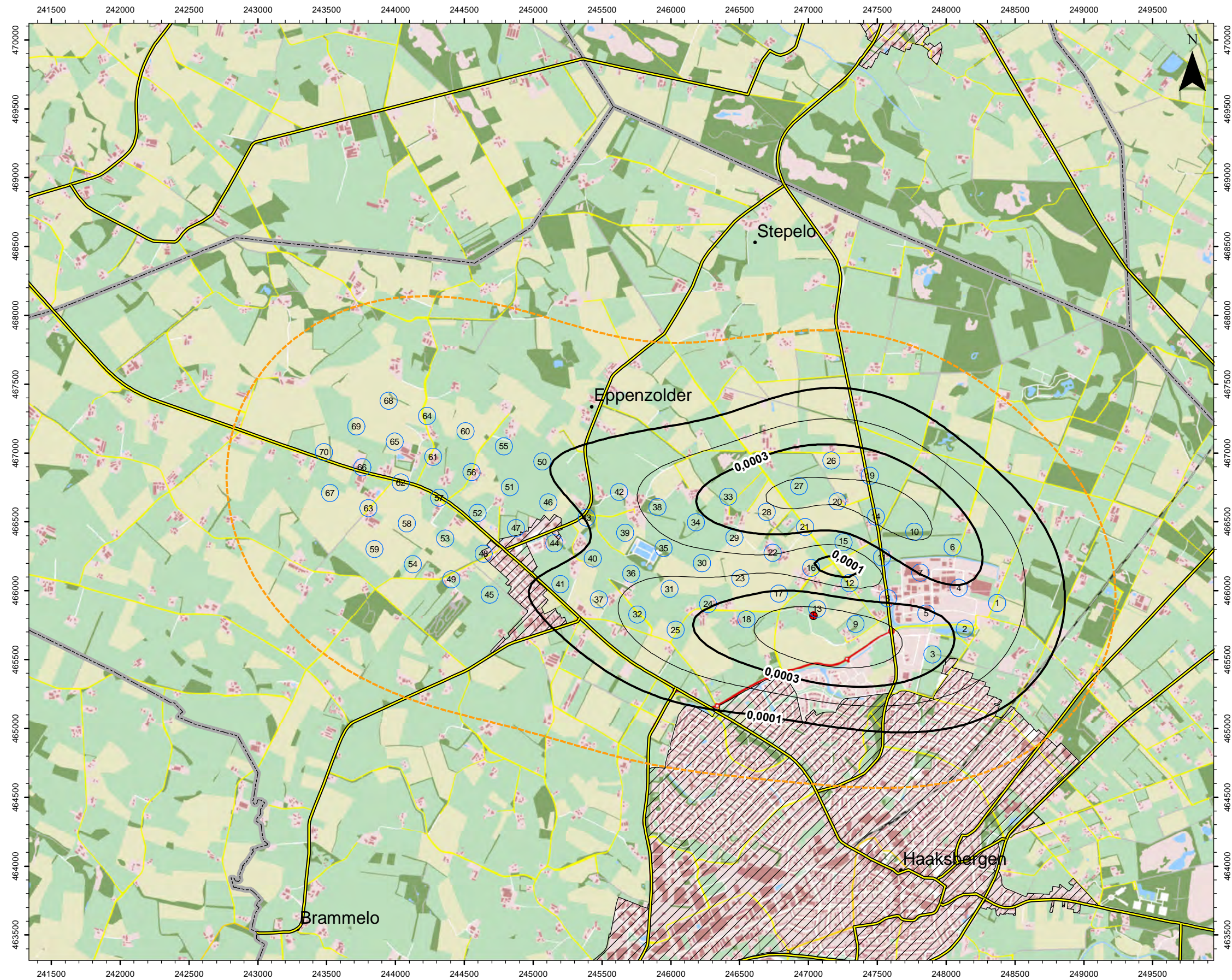

**Enclosure 15: Isidorushoeve – Resulting tilts [m/m] –  $\beta=40^\circ$  – 25 years after start of production**





**Legend**

-  Rock mechanical envelope: 125 m
-  Estimated boundary of subsidence trough (2 cm isocatabase, angle of draw 30°, 100 a after start of production)
-  ISH-01
-  Municipal boundary
-  Residential area
-  Roads
-  Isoline [m/m]

**Reference**

MWH B.V. (12/2008):  
Study of the Salt Mining  
Possibilities in the Haaksbergen  
Area, the Netherlands, report,  
82 pp + appendices/enclosures.

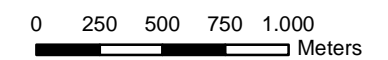







**Enclosure 16: Isidorushoeve – Resulting tilts [m/m] –  $\beta=40^\circ$  – 50 years after start of production**





**Legend**

-  Rock mechanical envelope: 125 m
-  Estimated boundary of subsidence trough (2 cm isocatabase, angle of draw 30°, 100 a after start of production)
-  ISH-01
-  Municipal boundary
-  Residential area
-  Roads
-  Isoline [m/m]

**Reference**

MWH B.V. (12/2008):  
Study of the Salt Mining  
Possibilities in the Haaksbergen  
Area, the Netherlands, report,  
82 pp + appendices/enclosures.









**Enclosure 17: Isidorushoeve – Resulting tilts [m/m] –  $\beta=40^\circ$  – 75 years after start of production**





**Legend**

-  Rock mechanical envelope: 125 m
-  Estimated boundary of subsidence trough (2 cm isocatabase, angle of draw 30°, 100 a after start of production)
-  ISH-01
-  Municipal boundary
-  Residential area
-  Roads
-  Isoline [m/m]

**Reference**

MWH B.V. (12/2008):  
Study of the Salt Mining  
Possibilities in the Haaksbergen  
Area, the Netherlands, report,  
82 pp + appendices/enclosures.

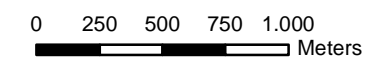





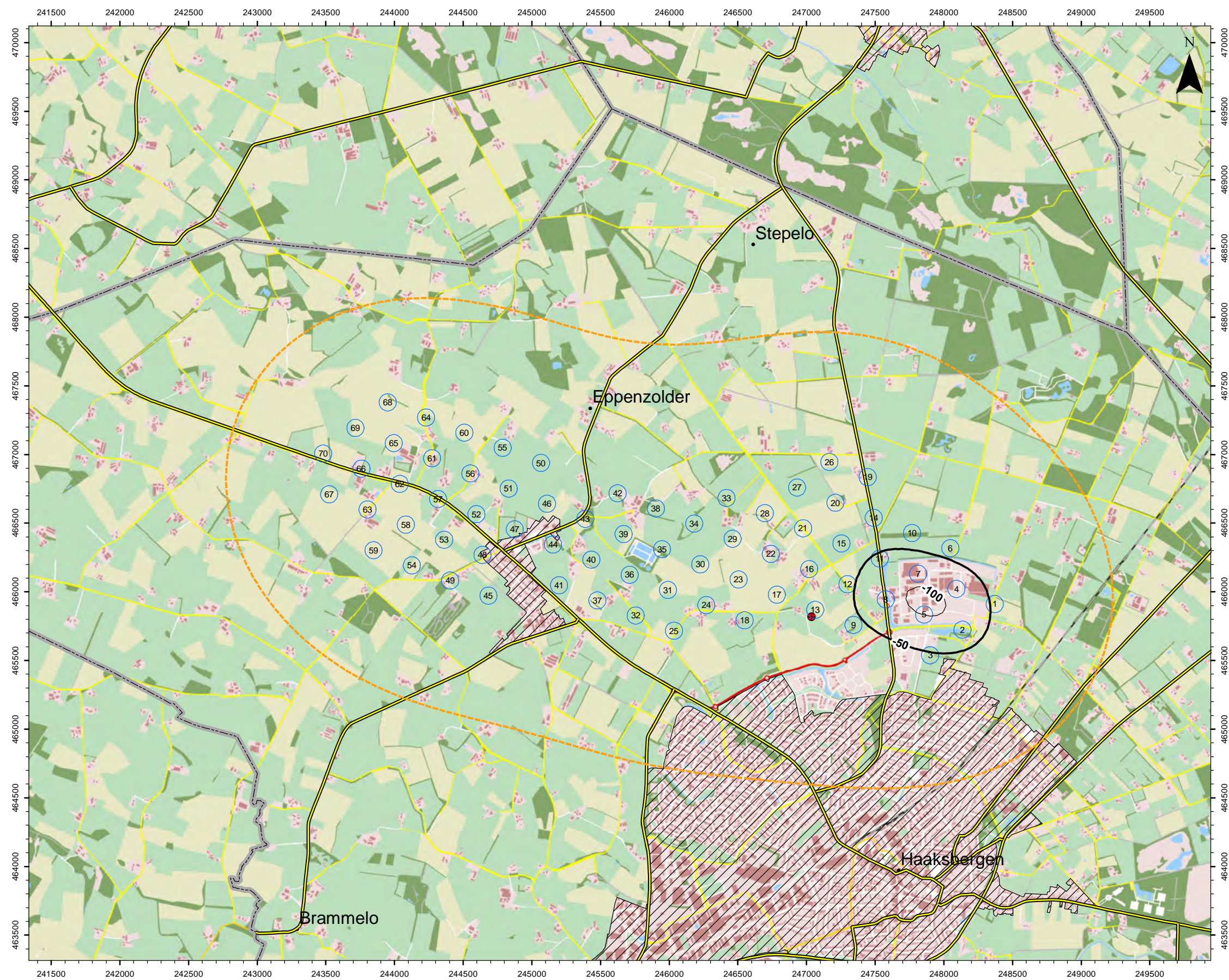

**Enclosure 18: Isidorushoeve – Resulting tilts [m/m] –  $\beta=40^\circ$  – 100 years after start of production**





**Legend**

-  Rock mechanical envelope: 125 m
-  Estimated boundary of subsidence trough (2 cm isocatabase, angle of draw 30°, 100 a after start of production)
-  ISH-01
-  Municipal boundary
-  Residential area
-  Roads
-  Isoline [mm/km]

**Reference**

MWH B.V. (12/2008):  
Study of the Salt Mining  
Possibilities in the Haaksbergen  
Area, the Netherlands, report,  
82 pp + appendices/enclosures.

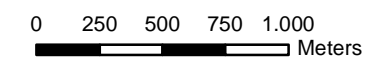





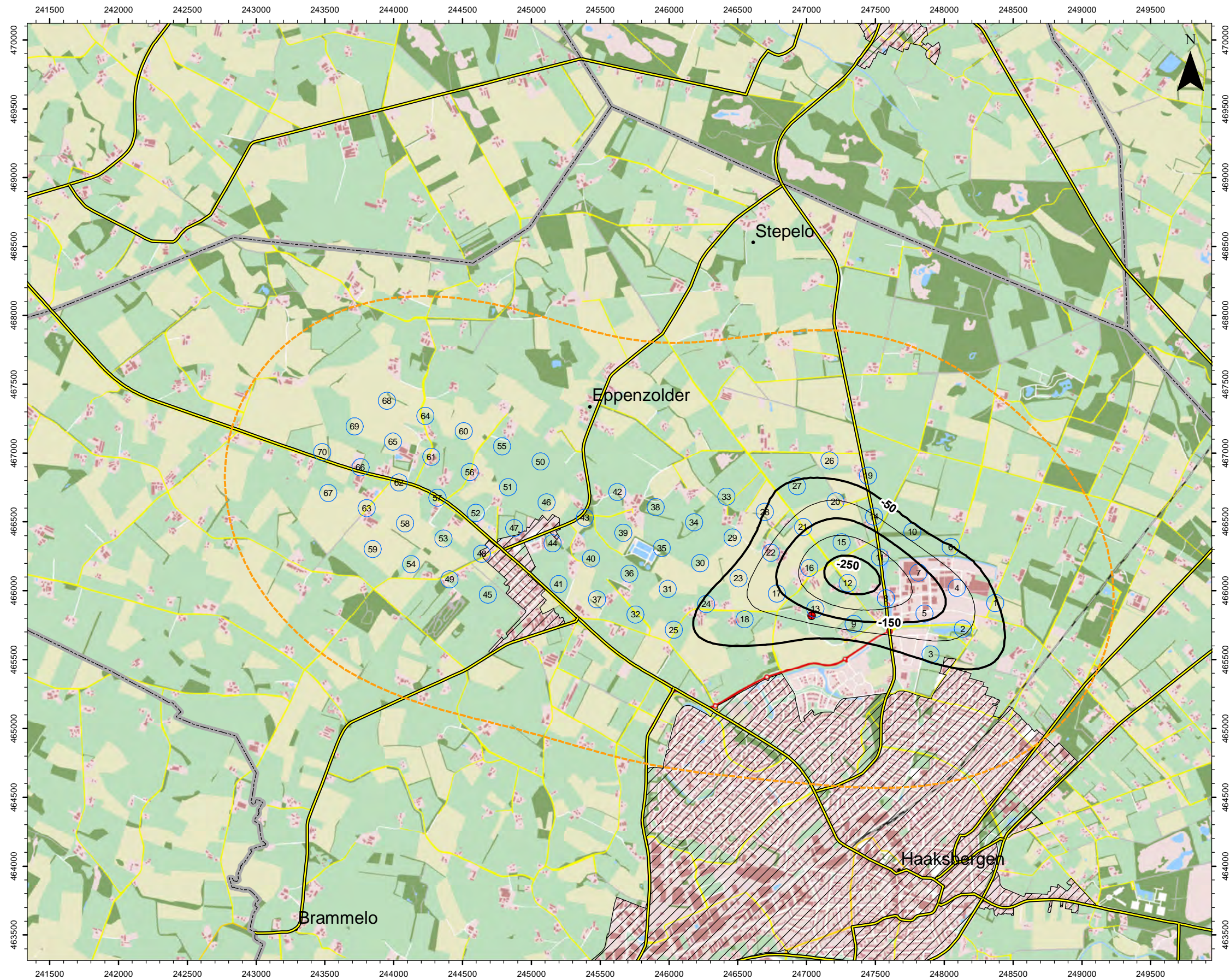

**Enclosure 19: Isidorushoeve – Compressive strains [mm/km] –  $\beta=40^\circ$  – 10 years after start of production**





**Legend**

-  Rock mechanical envelope: 125 m
-  Estimated boundary of subsidence trough (2 cm isocatabase, angle of draw 30°, 100 a after start of production)
-  ISH-01
-  Municipal boundary
-  Residential area
-  Roads
-  Isoline [mm/km]

**Reference**

MWH B.V. (12/2008):  
Study of the Salt Mining  
Possibilities in the Haaksbergen  
Area, the Netherlands, report,  
82 pp + appendices/enclosures.

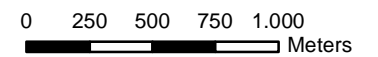





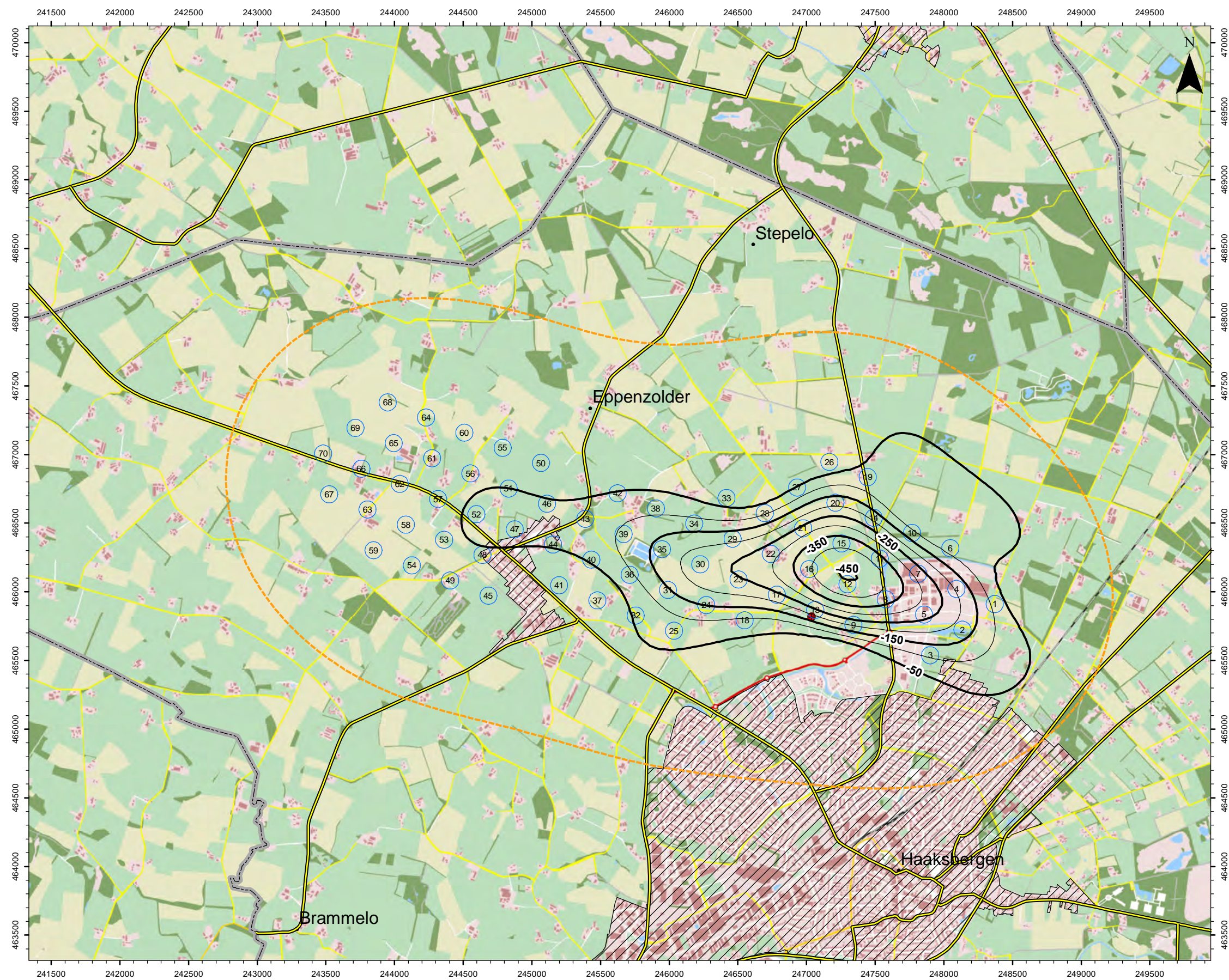

**Enclosure 20: Isidorushoeve – Compressive strains [mm/km] –  $\beta=40^\circ$  – 25 years after start of production**





**Legend**

-  Rock mechanical envelope: 125 m
-  Estimated boundary of subsidence trough (2 cm isocatabase, angle of draw 30°, 100 a after start of production)
-  ISH-01
-  Municipal boundary
-  Residential area
-  Roads
-  Isoline [mm/km]

**Reference**

MWH B.V. (12/2008):  
Study of the Salt Mining  
Possibilities in the Haaksbergen  
Area, the Netherlands, report,  
82 pp + appendices/enclosures.

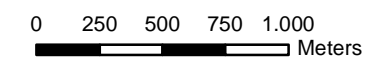





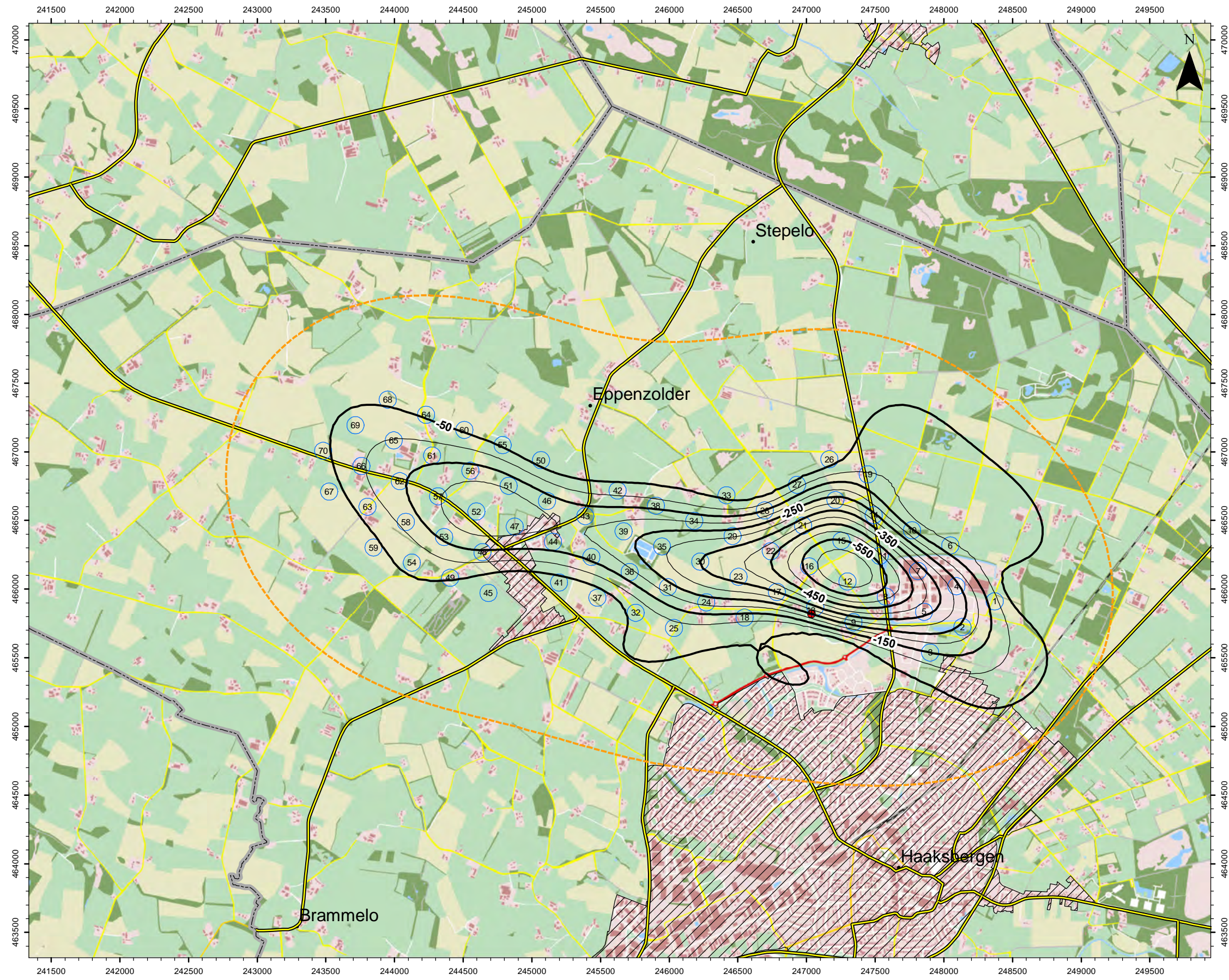

**Enclosure 21: Isidorushoeve – Compressive strains [mm/km] –  $\beta=40^\circ$  – 50 years after start of production**





**Legend**

-  Rock mechanical envelope: 125 m
-  Estimated boundary of subsidence trough (2 cm isocatabase, angle of draw 30°, 100 a after start of production)
-  ISH-01
-  Municipal boundary
-  Residential area
-  Roads
-  Isoline [mm/km]

**Reference**

MWH B.V. (12/2008):  
 Study of the Salt Mining  
 Possibilities in the Haaksbergen  
 Area, the Netherlands, report,  
 82 pp + appendices/enclosures.









**Enclosure 22: Isidorushoeve – Compressive strains [mm/km] –  $\beta=40^\circ$  – 75 years after start of production**





**Legend**

-  Rock mechanical envelope: 125 m
-  Estimated boundary of subsidence trough (2 cm isocatabase, angle of draw 30°, 100 a after start of production)
-  ISH-01
-  Municipal boundary
-  Residential area
-  Roads
-  Isoline [mm/km]

**Reference**

MWH B.V. (12/2008):  
Study of the Salt Mining  
Possibilities in the Haaksbergen  
Area, the Netherlands, report,  
82 pp + appendices/enclosures.

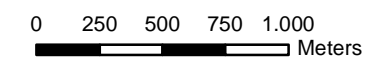





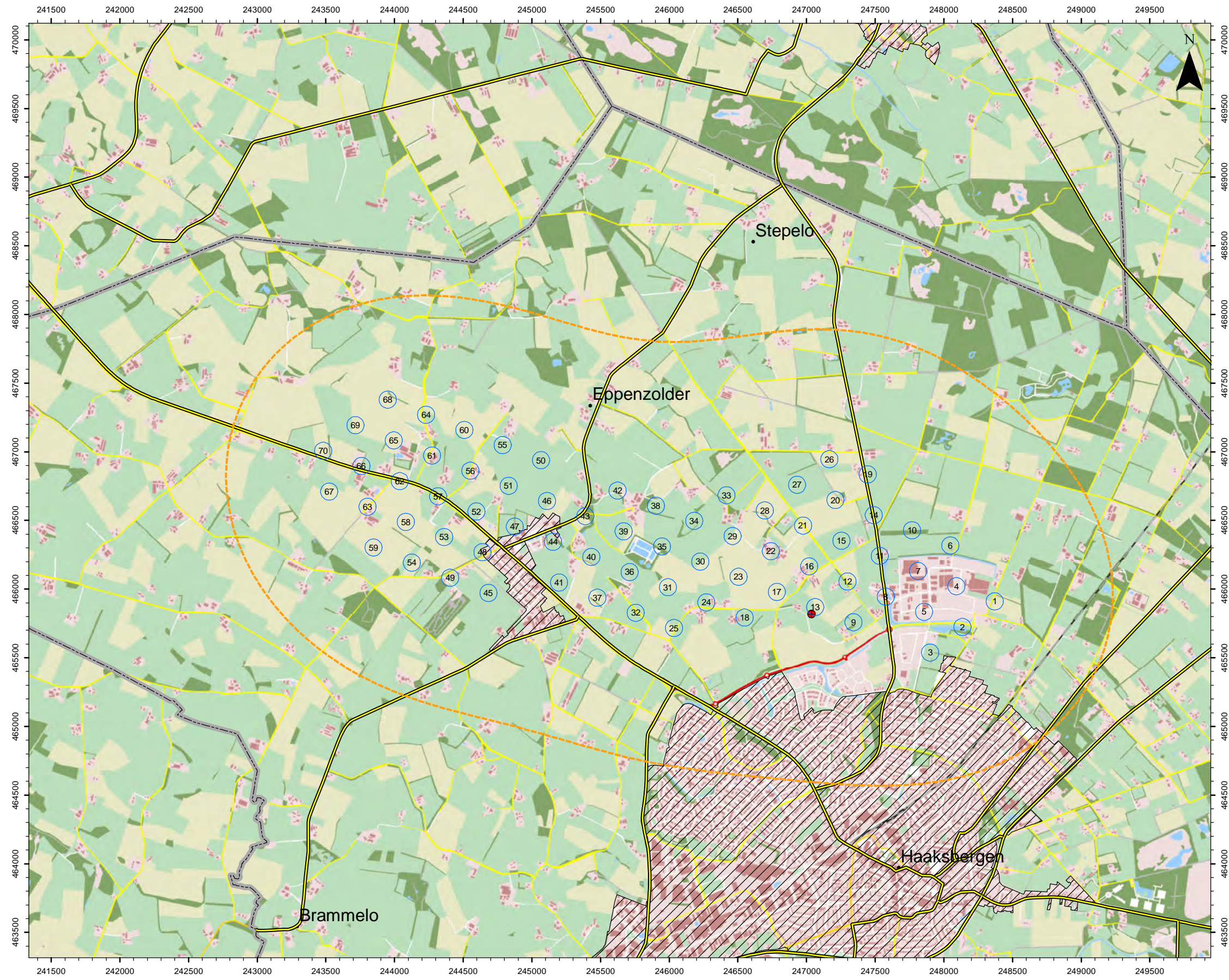

**Enclosure 23: Isidorushoeve – Compressive strains [mm/km] –  $\beta=40^\circ$  – 100 years after start of production**





**Legend**

-  Rock mechanical envelope: 125 m
-  Estimated boundary of subsidence trough (2 cm isocatabase, angle of draw 30°, 100 a after start of production)
-  ISH-01
-  Municipal boundary
-  Residential area
-  Roads
-  Isoline [mm/km]

**Reference**

MWH B.V. (12/2008):  
Study of the Salt Mining  
Possibilities in the Haaksbergen  
Area, the Netherlands, report,  
82 pp + appendices/enclosures.







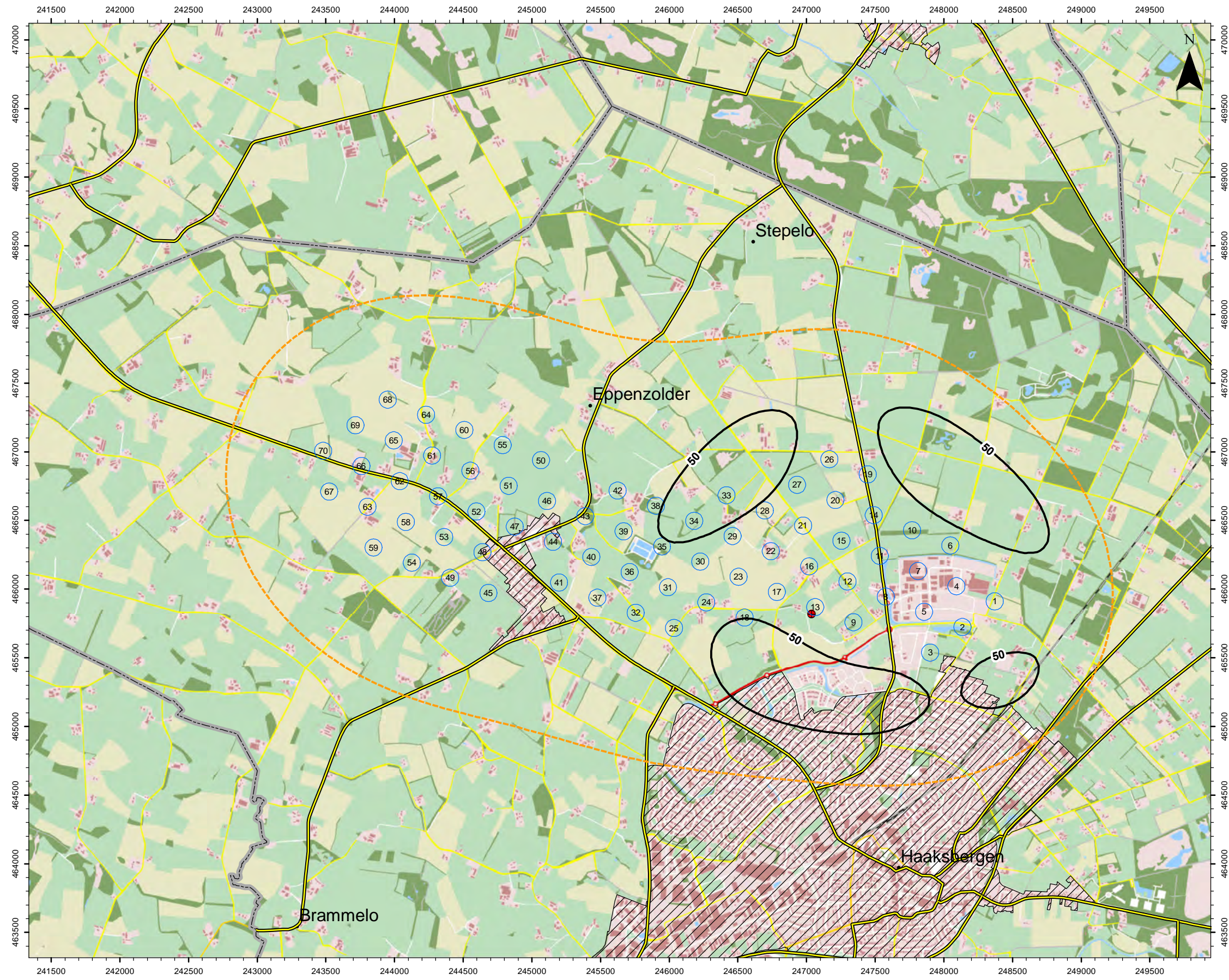

**Enclosure 24: Isidorushoeve – Tensile strains [mm/km] –  $\beta=40^\circ$  – 10 years after start of production**





**Legend**

-  Rock mechanical envelope: 125 m
-  Estimated boundary of subsidence trough (2 cm isocatabase, angle of draw 30°, 100 a after start of production)
-  ISH-01
-  Municipal boundary
-  Residential area
-  Roads
-  Isoline [mm/km]

**Reference**

MWH B.V. (12/2008):  
Study of the Salt Mining  
Possibilities in the Haaksbergen  
Area, the Netherlands, report,  
82 pp + appendices/enclosures.







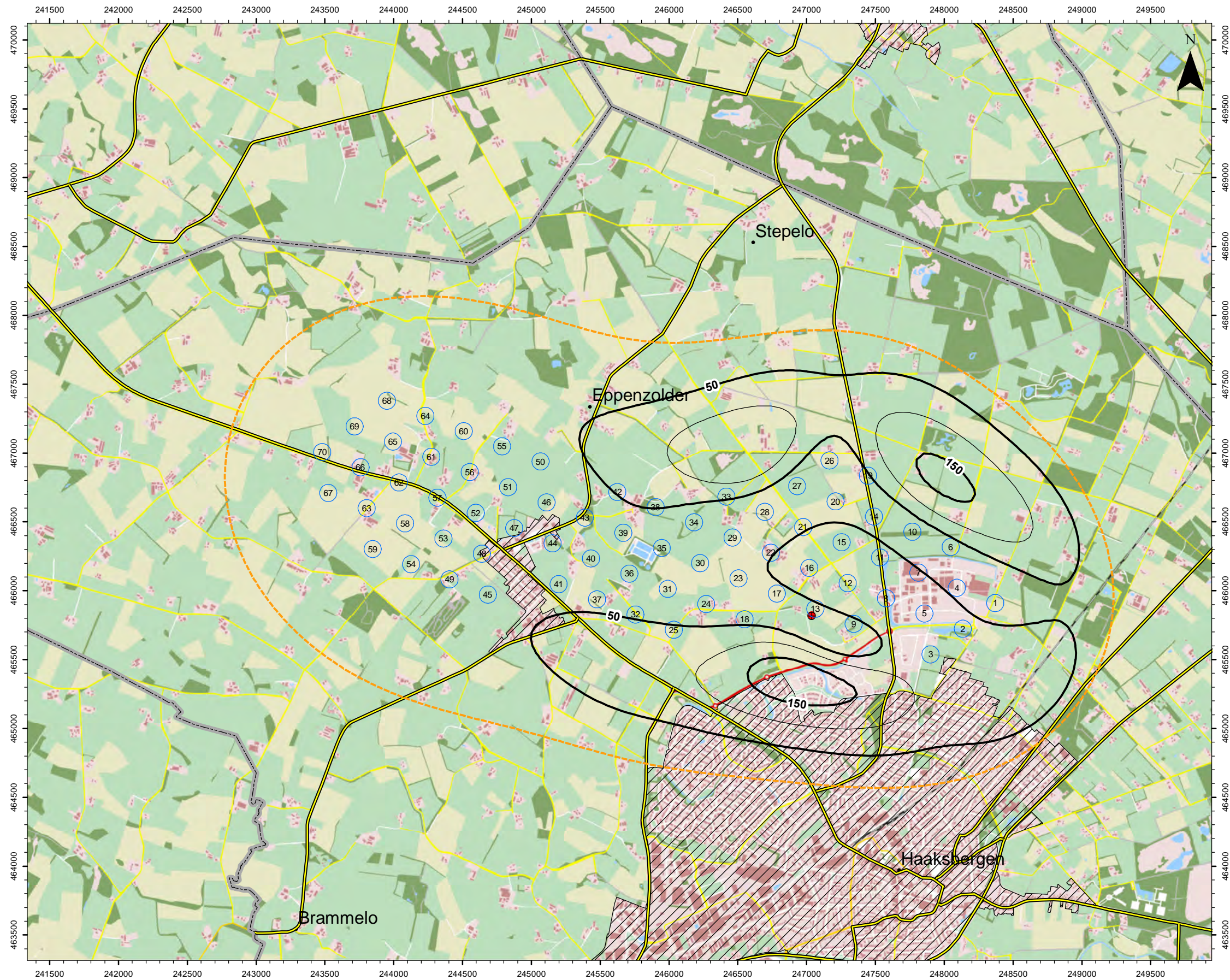

**Enclosure 25: Isidorushoeve – Tensile strains [mm/km] –  $\beta=40^\circ$  – 25 years after start of production**





**Legend**

-  Rock mechanical envelope: 125 m
-  Estimated boundary of subsidence trough (2 cm isocatabase, angle of draw 30°, 100 a after start of production)
-  ISH-01
-  Municipal boundary
-  Residential area
-  Roads
-  Isoline [mm/km]

**Reference**

MWH B.V. (12/2008):  
Study of the Salt Mining  
Possibilities in the Haaksbergen  
Area, the Netherlands, report,  
82 pp + appendices/enclosures.

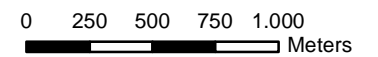







**Enclosure 26: Isidorushoeve – Tensile strains [mm/km] –  $\beta=40^\circ$  – 50 years after start of production**





**Legend**

-  Rock mechanical envelope: 125 m
-  Estimated boundary of subsidence trough (2 cm isocatabase, angle of draw 30°, 100 a after start of production)
-  ISH-01
-  Municipal boundary
-  Residential area
-  Roads
-  Isoline [mm/km]

**Reference**

MWH B.V. (12/2008):  
Study of the Salt Mining  
Possibilities in the Haaksbergen  
Area, the Netherlands, report,  
82 pp + appendices/enclosures.









**Enclosure 27: Isidorushoeve – Tensile strains [mm/km] –  $\beta=40^\circ$  – 75 years after start of production**





**Legend**

-  Rock mechanical envelope: 125 m
-  Estimated boundary of subsidence trough (2 cm isocatabase, angle of draw 30°, 100 a after start of production)
-  ISH-01
-  Municipal boundary
-  Residential area
-  Roads
-  Isoline [mm/km]

**Reference**

MWH B.V. (12/2008):  
Study of the Salt Mining  
Possibilities in the Haaksbergen  
Area, the Netherlands, report,  
82 pp + appendices/enclosures.

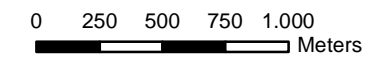





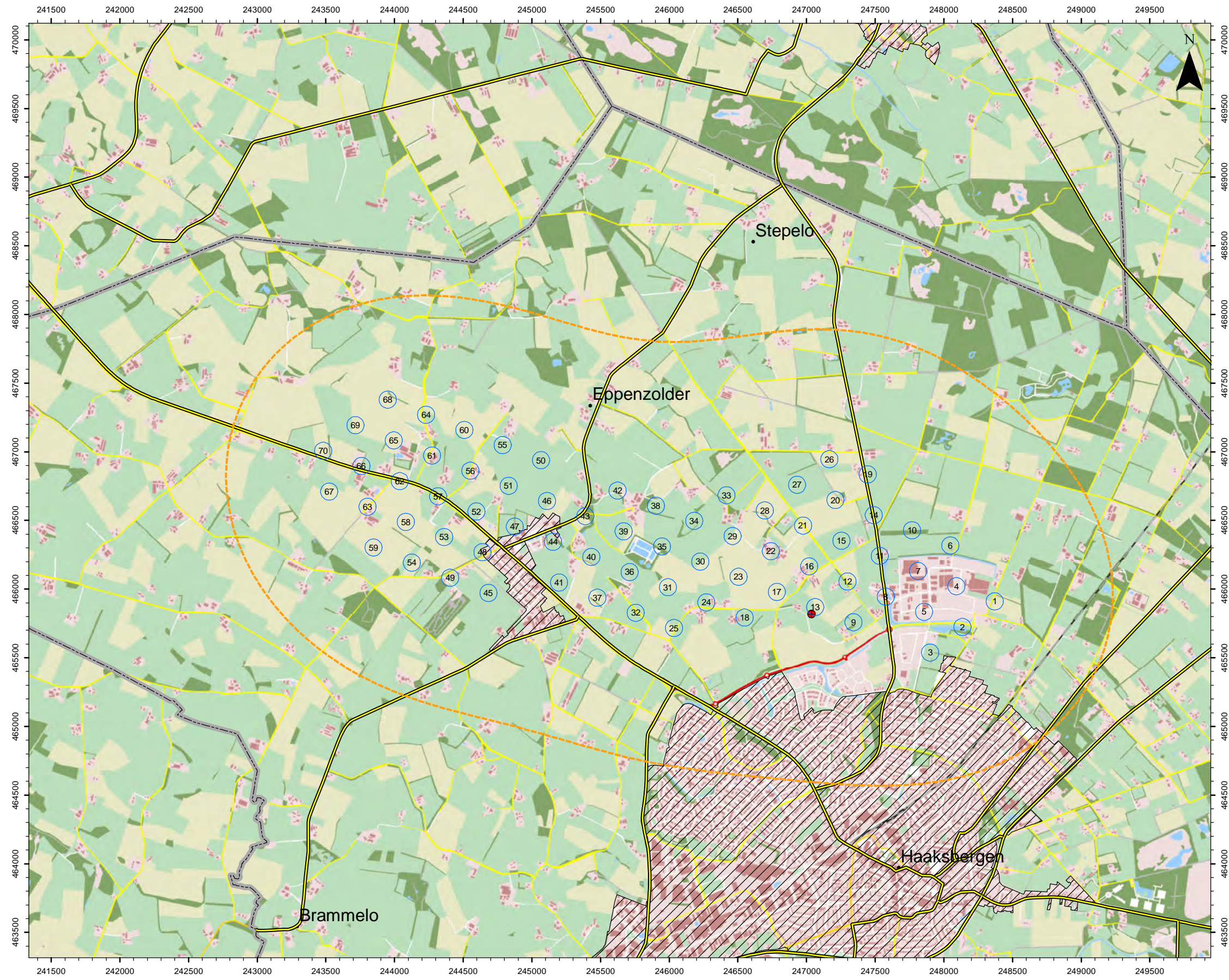

**Enclosure 28: Isidorushoeve – Tensile strains [mm/km] –  $\beta=40^\circ$  – 100 years after start of production**





**Legend**

-  Rock mechanical envelope: 125 m
-  Estimated boundary of subsidence trough (2 cm isocatabase, angle of draw 30°, 100 a after start of production)
-  ISH-01
-  Municipal boundary
-  Residential area
-  Roads
-  Isoline [1/km]

**Reference**

MWH B.V. (12/2008):  
Study of the Salt Mining  
Possibilities in the Haaksbergen  
Area, the Netherlands, report,  
82 pp + appendices/enclosures.







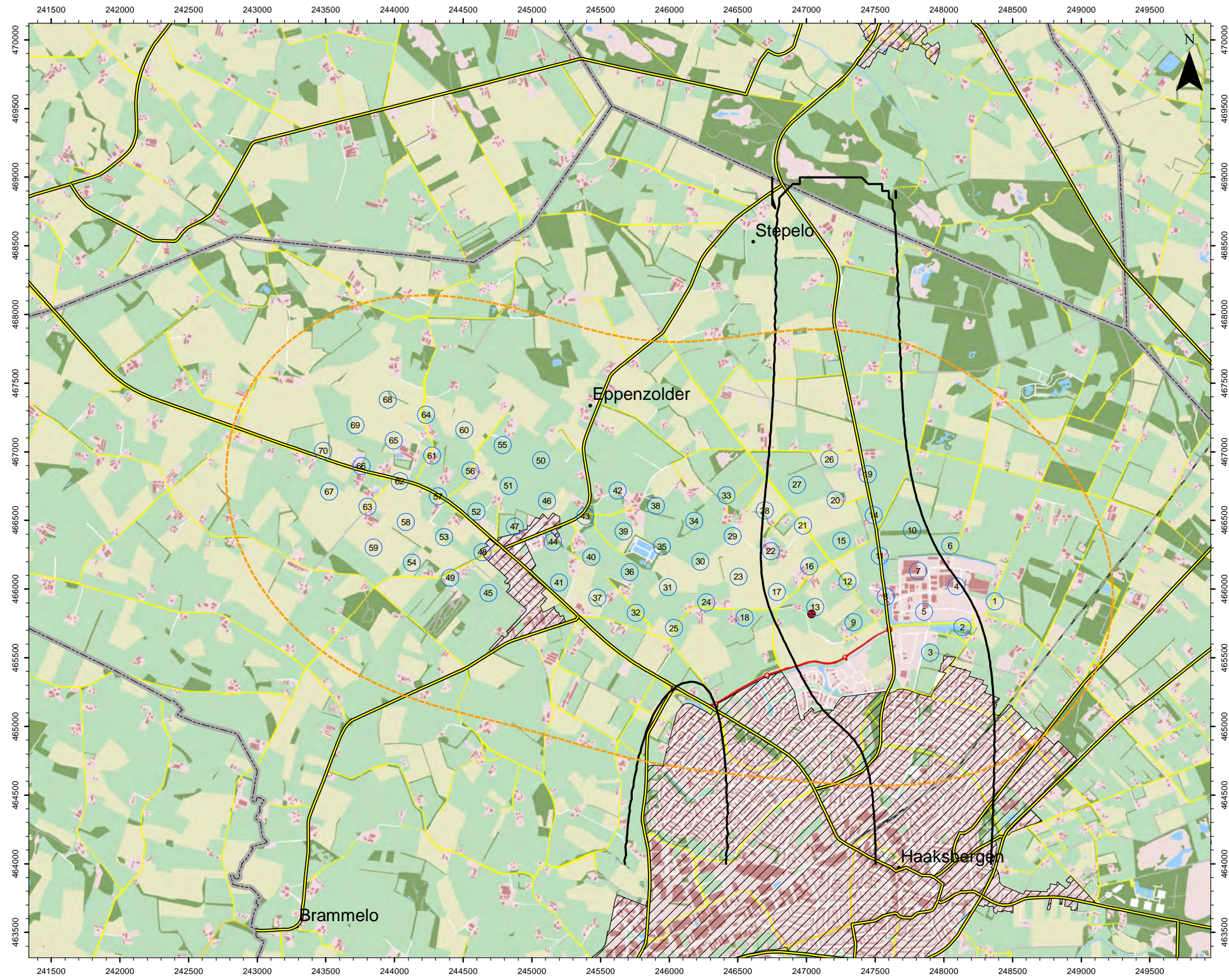

**Enclosure 29: Isidorushoeve – Curvature with reference to Easting [1/km] –  $\beta=40^\circ$  – 10 years after start of production**





**Legend**

-  Rock mechanical envelope: 125 m
-  Estimated boundary of subsidence trough (2 cm isocatabase, angle of draw 30°, 100 a after start of production)
-  ISH-01
-  Municipal boundary
-  Residential area
-  Roads
-  Isoline [1/km]

**Reference**

MWH B.V. (12/2008):  
Study of the Salt Mining  
Possibilities in the Haaksbergen  
Area, the Netherlands, report,  
82 pp + appendices/enclosures.







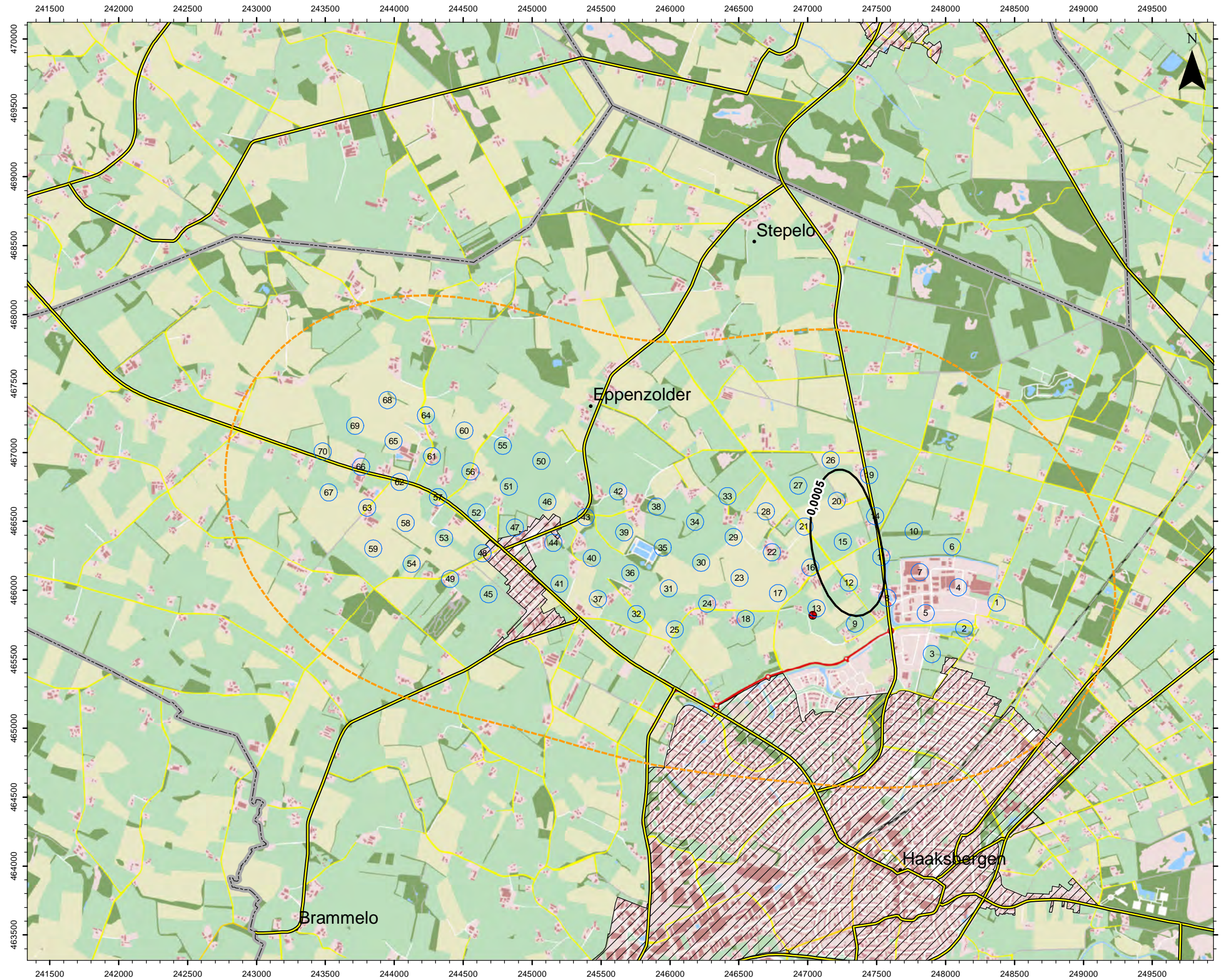

**Enclosure 30: Isidorushoeve – Curvature with reference to Easting [1/km] –  $\beta=40^\circ$  – 25 years after start of production**





**Legend**

-  Rock mechanical envelope: 125 m
-  Estimated boundary of subsidence trough (2 cm isocatabase, angle of draw 30°, 100 a after start of production)
-  ISH-01
-  Municipal boundary
-  Residential area
-  Roads
-  Isoline [1/km]

**Reference**

MWH B.V. (12/2008):  
Study of the Salt Mining  
Possibilities in the Haaksbergen  
Area, the Netherlands, report,  
82 pp + appendices/enclosures.

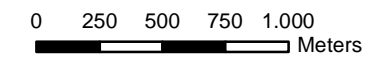

**Enclosure 31: Isidorushoeve – Curvature with reference to Easting [1/km] –  $\beta=40^\circ$  – 50 years after start of production**



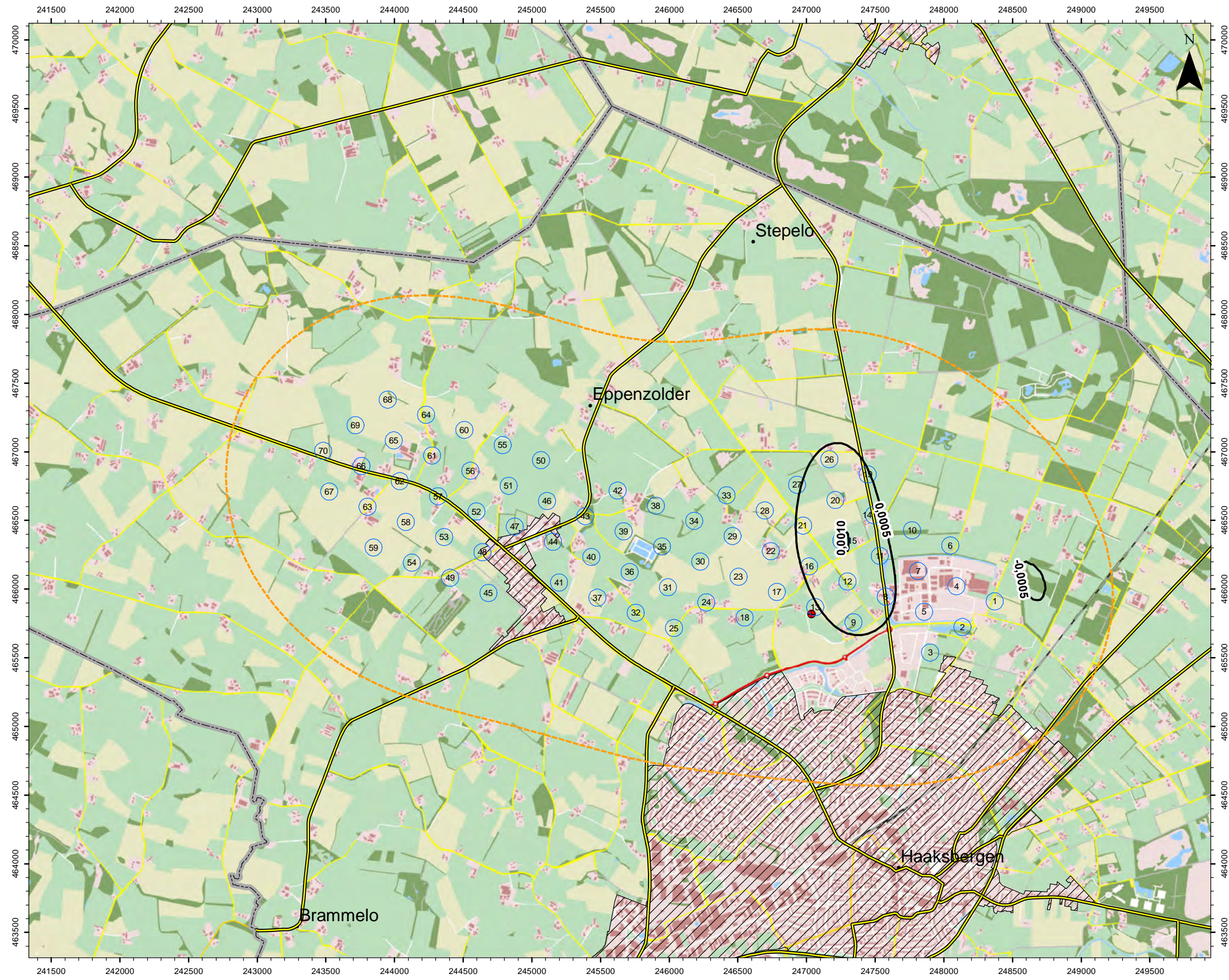

**Legend**

- Rock mechanical envelope: 125 m
- - - Estimated boundary of subsidence trough (2 cm isocatabase, angle of draw 30°, 100 a after start of production)
- ISH-01
- Municipal boundary
- Residential area
- Roads
- Isoline [1/km]

**Reference**

MWH B.V. (12/2008):  
Study of the Salt Mining  
Possibilities in the Haaksbergen  
Area, the Netherlands, report,  
82 pp + appendices/enclosures.







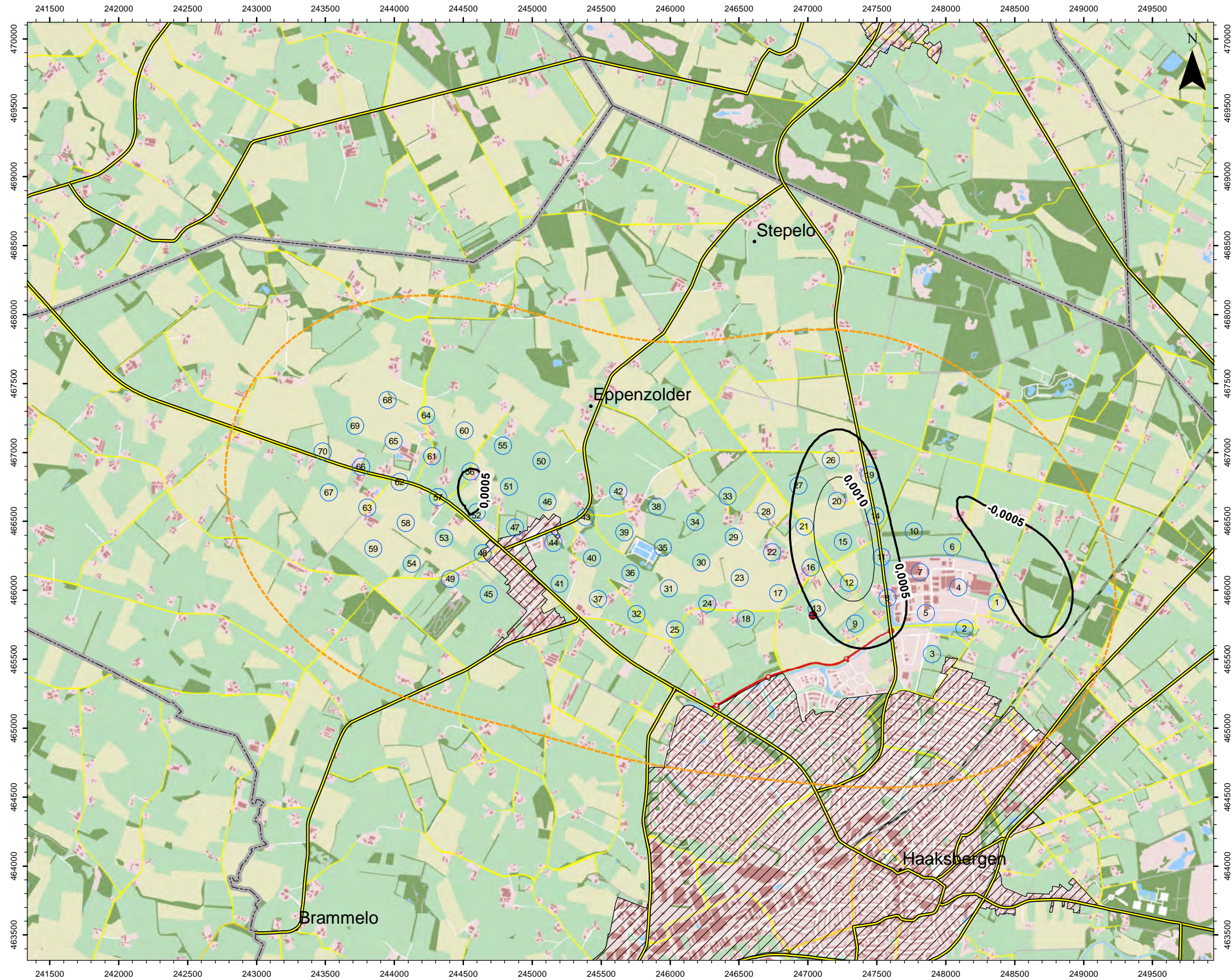

**Enclosure 32: Isidorushoeve – Curvature with reference to Easting [1/km] –  $\beta=40^\circ$  – 75 years after start of production**





**Legend**

-  Rock mechanical envelope: 125 m
-  Estimated boundary of subsidence trough (2 cm isocatabase, angle of draw 30°, 100 a after start of production)
-  ISH-01
-  Municipal boundary
-  Residential area
-  Roads
-  Isoline [1/km]

**Reference**

MWH B.V. (12/2008):  
Study of the Salt Mining  
Possibilities in the Haaksbergen  
Area, the Netherlands, report,  
82 pp + appendices/enclosures.

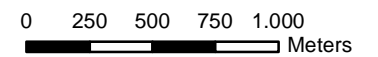





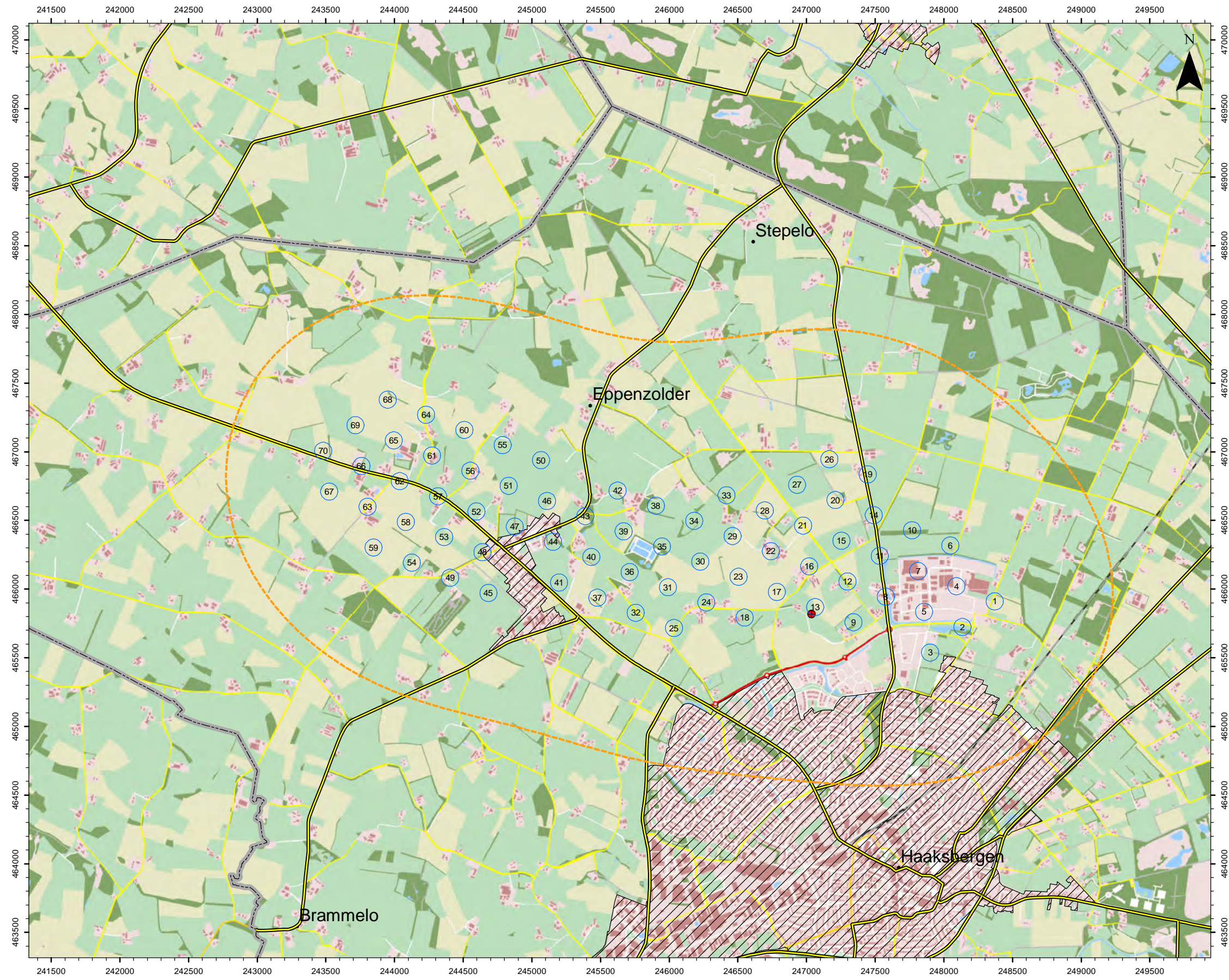

**Enclosure 33: Isidorushoeve – Curvature with reference to Easting [1/km] –  $\beta=40^\circ$  – 100 years after start of production**





**Legend**

-  Rock mechanical envelope: 125 m
-  Estimated boundary of subsidence trough (2 cm isocatabase, angle of draw 30°, 100 a after start of production)
-  ISH-01
-  Municipal boundary
-  Residential area
-  Roads
-  Isoline [1/km]

**Reference**

MWH B.V. (12/2008):  
Study of the Salt Mining  
Possibilities in the Haaksbergen  
Area, the Netherlands, report,  
82 pp + appendices/enclosures.







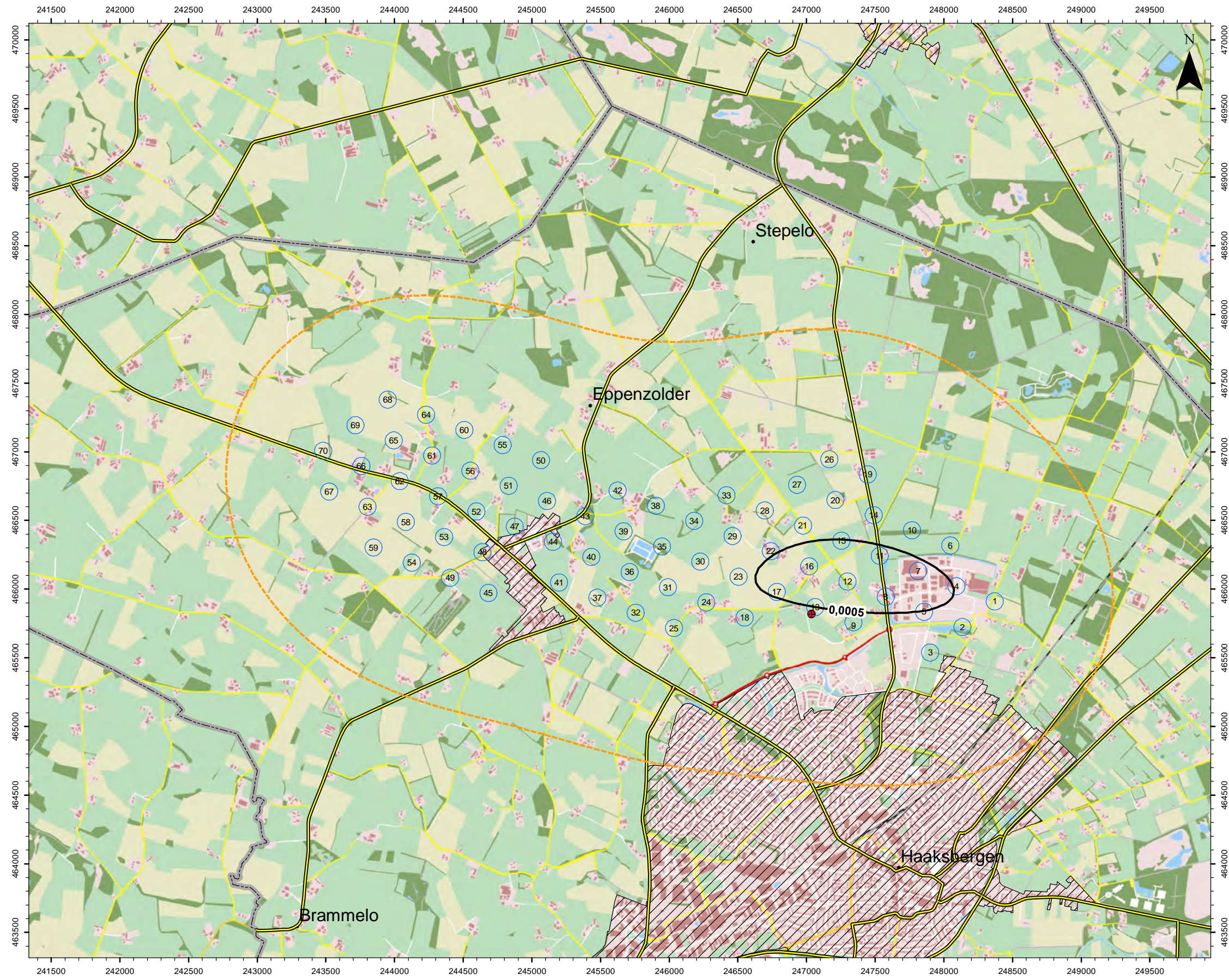

**Enclosure 34: Isidorushoeve – Curvature with reference to Northing [1/km] –  $\beta=40^\circ$  – 10 years after start of production**





**Legend**

-  Rock mechanical envelope: 125 m
-  Estimated boundary of subsidence trough (2 cm isocatabase, angle of draw 30°, 100 a after start of production)
-  ISH-01
-  Municipal boundary
-  Residential area
-  Roads
-  Isoline [1/km]

**Reference**

MWH B.V. (12/2008):  
Study of the Salt Mining  
Possibilities in the Haaksbergen  
Area, the Netherlands, report,  
82 pp + appendices/enclosures.







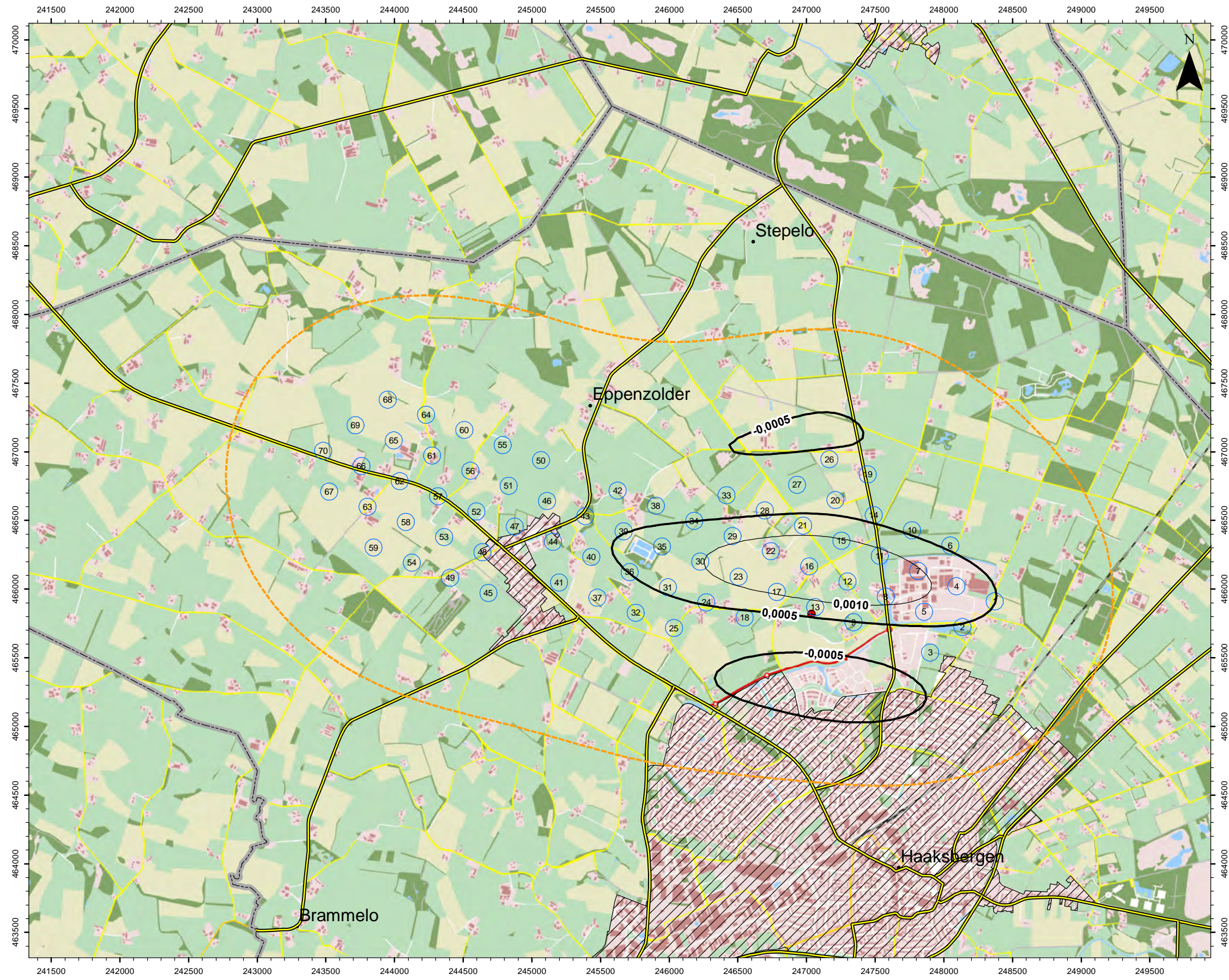

**Enclosure 35: Isidorushoeve – Curvature with reference to Northing [1/km] –  $\beta=40^\circ$  – 25 years after start of production**





**Legend**

-  Rock mechanical envelope: 125 m
-  Estimated boundary of subsidence trough (2 cm isocatabase, angle of draw 30°, 100 a after start of production)
-  ISH-01
-  Municipal boundary
-  Residential area
-  Roads
-  Isoline [1/km]

**Reference**

MWH B.V. (12/2008):  
Study of the Salt Mining  
Possibilities in the Haaksbergen  
Area, the Netherlands, report,  
82 pp + appendices/enclosures.







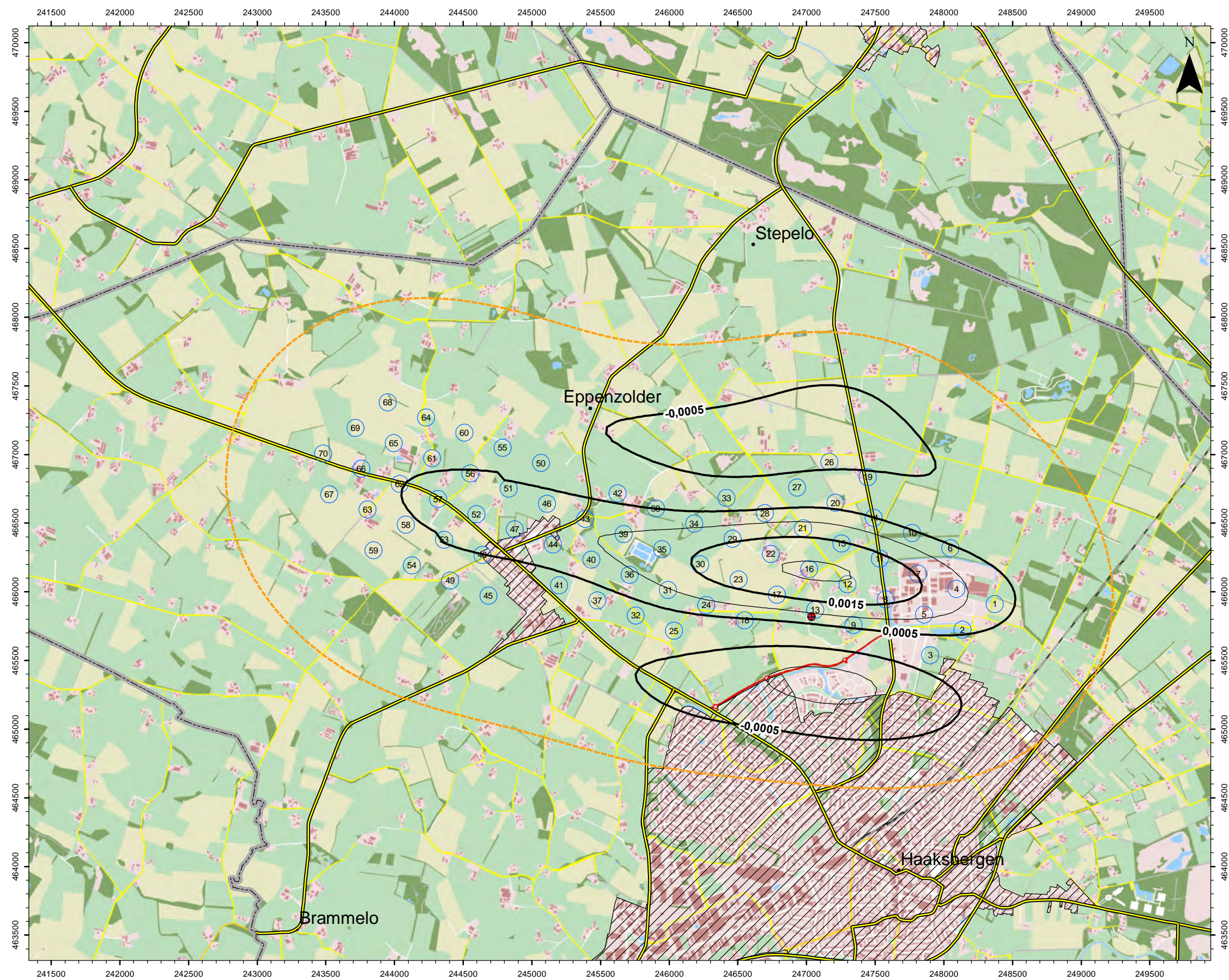

**Enclosure 36: Isidorushoeve – Curvature with reference to Northing [1/km] –  $\beta=40^\circ$  – 50 years after start of production**





**Legend**

-  Rock mechanical envelope: 125 m
-  Estimated boundary of subsidence trough (2 cm isocatabase, angle of draw 30°, 100 a after start of production)
-  ISH-01
-  Municipal boundary
-  Residential area
-  Roads
-  Isoline [1/km]

**Reference**

MWH B.V. (12/2008):  
Study of the Salt Mining  
Possibilities in the Haaksbergen  
Area, the Netherlands, report,  
82 pp + appendices/enclosures.

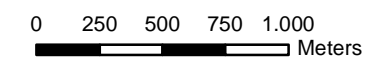





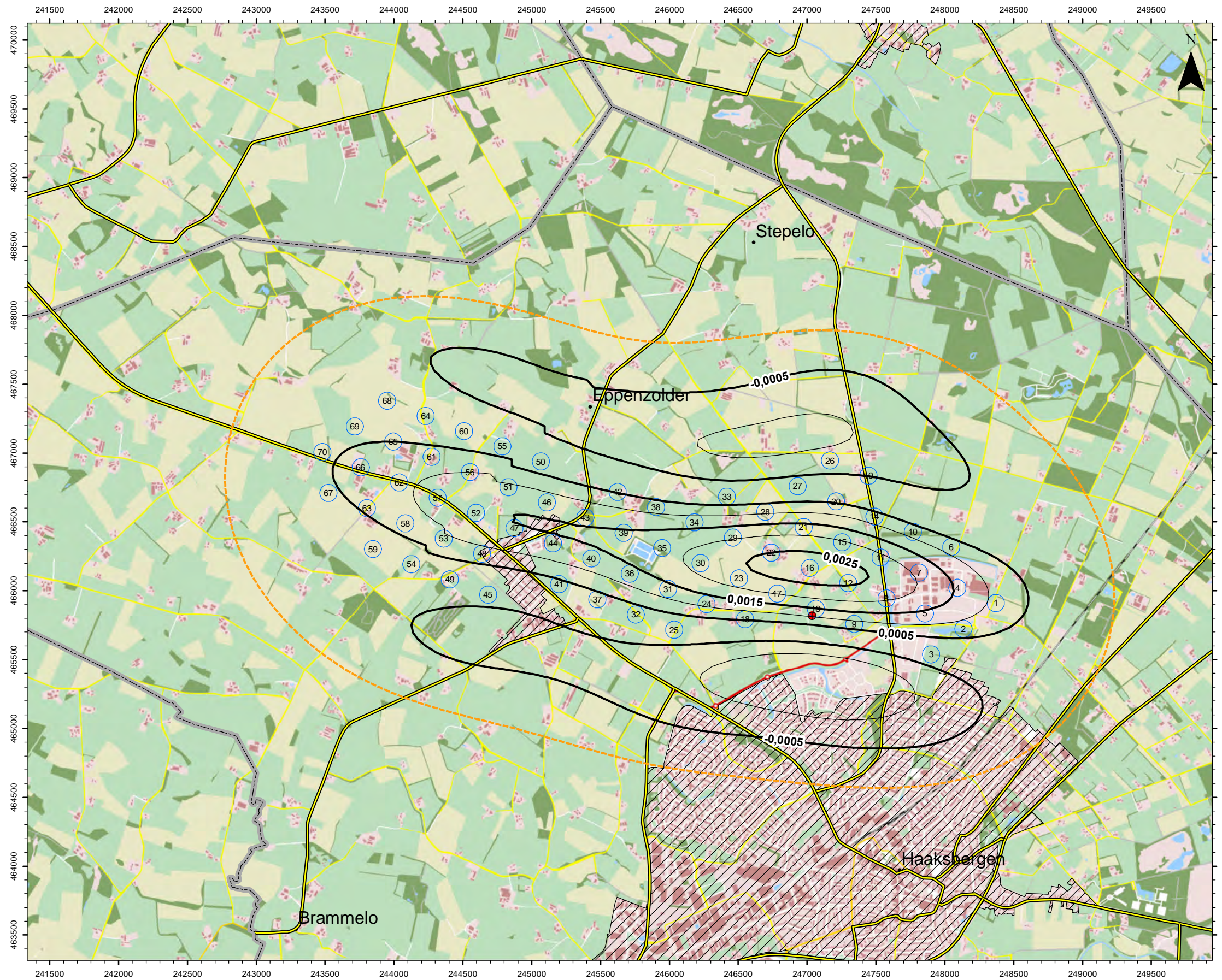

**Enclosure 37: Isidorushoeve – Curvature with reference to Northing [1/km] –  $\beta=40^\circ$  – 75 years after start of production**





**Legend**

-  Rock mechanical envelope: 125 m
-  Estimated boundary of subsidence trough (2 cm isocatabase, angle of draw 30°, 100 a after start of production)
-  ISH-01
-  Municipal boundary
-  Residential area
-  Roads
-  Isoline [1/km]

**Reference**

MWH B.V. (12/2008):  
Study of the Salt Mining  
Possibilities in the Haaksbergen  
Area, the Netherlands, report,  
82 pp + appendices/enclosures.

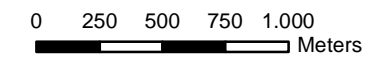

**Enclosure 38: Isidorushoeve – Curvature with reference to Northing [1/km] –  $\beta=40^\circ$  – 100 years after start of production**



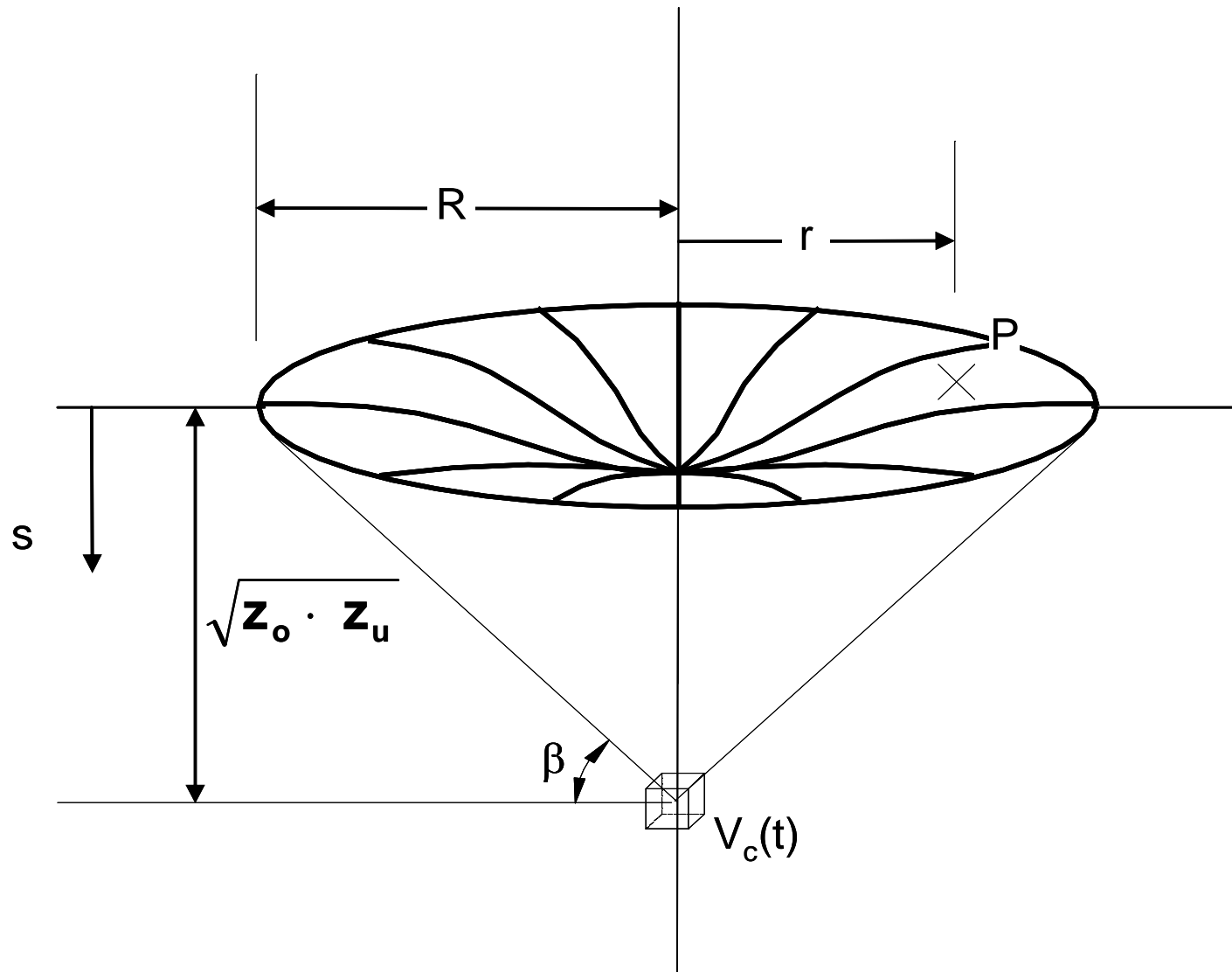

Enclosure A.1

Subsidence trough at surface due to volume losses at subsurface according to Neuhaus (1976)